

DIGITAL VIDEO RECORDER

Best picture quality - JPEG2000

# Stand-alone DVMR



16Channel Stand-alone DVMR

The most stable and reliable real stand-alone Digital Video Multiplex Recorder

## INSTALLATION & SAFEGUARDS

All the safety and operating instructions should be read before the unit is operated.

### Environment Condition for Installation

- To prevent electric shock or other hazard, do not expose units to rain, moisture, or dust.
- This unit should be located in an area with low humidity and a minimum of dust..
- Place this unit in a well-ventilated place and do not place heat-generating objects on this unit.
- This unit should not be located in an area where it is likely to be subjected to mechanical shocks.

### Before You Start

- Ensure the power switch is in the OFF position prior to starting.
- Do not attempt to service this unit yourself as opening or removing covers may expose you to dangerous voltage or other hazards.
- Installation should be performed by qualified service personnel only.
- This unit should be operated only from the type of power source indicated on the manufacturer's label and with the power supply included with the unit.

### Notice

- Be aware thoroughly about the power connection before installation of the unit.
- Before initial configuration or operation you must first set the TIME/DATE, followed by setting the unit to the FACTORY DEFAULT settings, lastly clearing the HDD. Please follow these steps in order.
- Before installing a second HDD, ensure that the drive conforms to the specifications listed on the specifications page at the end of this manual. When installing a second HDD, set the drive to SLAVE. After installation, first reset the TIME/DATE, followed by resetting the unit to the FACTORY DEFAULT settings, lastly clearing the new HDD.
- Pull the unit out of record mode prior to cutting power to the unit. Do this by entering the setup menu, followed by switching the unit off. Powering off the unit while writing to the disks can cause critical malfunctions. (ex: Recording Error, Playback Error, System Error)
- When you set the record type, you have to set the Record Configuration and also Schedule Setup. This unit records as per the Record type & Schedule setup.
- The [REC] button on the front panel is for emergency record using highest image quality.



The lightning flash with arrowhead symbol within an equilateral triangle is intended to alert the user of this equipment that there are dangerous voltages within the enclosure which may be of sufficient magnitude to constitute a risk of electric shock.



The exclamation point within an equilateral triangle is intended to alert the user to presence of important operating and maintenance(Servicing) instructions in the literature accompanying the appliance.

## Contents

CHAP. 1	Features & Package Contents	-----	4
1-1.	Features	-----	4
1-2.	Package Contents	-----	5
CHAP. 2	Function of Each Button	-----	6
2-1.	Front	-----	6
2-2.	Rear	-----	8
CHAP. 3	Installation	-----	9
3-1.	Installation Configuration	-----	9
3-2.	Detailed Installation	-----	10
1)	Rack Mount	-----	10
2)	HDD(Hard Disk Drive)	-----	10
3)	Camera	-----	11
4)	Monitor	-----	11
5)	Power	-----	11
6)	VCR, Video Printer	-----	12
7)	Other External Device	-----	12
8)	Connector Pin Assignment	-----	13
9)	RS-232C ASCII-code	-----	13
CHAP. 4	Operation	-----	14
4-1.	System Log-in	-----	14
4-2.	Factory Default	-----	14
4-3.	Display Configuration	-----	15
4-4.	Live View Setup	-----	15
1)	Full / Multiple View	-----	15
2)	Sequencing Cameras	-----	16
3)	PIP View	-----	16
4)	Freeze View	-----	16
5)	Zoom View	-----	16
4-5.	Record	-----	17
4-6.	Playback	-----	17
4-7.	Search	-----	18

## Stand-alone DVR

4-8.	PTZ Camera Operation	-----	19
4-9.	Data Back-Up	-----	19
<b>CHAP. 5</b>	<b>Set Up</b>	-----	<b>20</b>
5-1.	Entering the Menu	-----	20
5-2.	Display Setup	-----	21
1)	Screen Display	-----	21
2)	Monitor Setup	-----	21
5-3.	Configuration	-----	22
1.	HDD Management	-----	22
2.	TIME/DATE Setup	-----	23
3.	Camera Setup	-----	23
4.	Interval Setup	-----	25
5.	Alarm Setup	-----	25
6.	Buzzer Setup	-----	26
7.	Password Setup	-----	26
8.	System Information	-----	26
5-4.	Record Setup	-----	27
1.	Record Configuration	-----	27
2.	Schedule Setup	-----	28
3.	Holiday Setup	-----	28
5-5.	Back-Up	-----	29
5-6.	External Device	-----	29
1.	TCP/IP Setup	-----	30
2.	RS-232C Setup	-----	30
3.	Pan Tilt Zoom Setup	-----	30
5-7.	FACTORY Default	-----	31
5-8.	Language Setup	-----	31
<b>CHAP. 6</b>	<b>Network Setup</b>	-----	<b>32</b>
6-1.	DVR Network Configuration	-----	32
6-2.	Remote Viewer Program	-----	36
6-3.	Back-Up CD Player	-----	41
<b>CHAP. 7</b>	<b>Specifications</b>	-----	<b>43</b>

## CHAP. 1 Features & Package Contents

### 1-1. Features

#### Live View

- Real time display per camera
- Auto Sequence
- PIP (Picture in picture)
- Digital Zoom
- Display Freeze
- Simple Playback mode
- Simple PTZ camera control

#### Record

- Variable Record resolution (For higher picture quality or higher recording speed)
- Efficient Image Quality setup in 5 steps
- Schedule Record / Holiday Record
- Event Record (Alarm / Motion)
- Emergency Record

#### Network

- View Live and Playback images across IP network
- Copy images across the network

#### Playback

- Search & Playback by Date/Time, Event and Camera
- Outstanding picture quality by JPEG 2000 compression algorithm (No mosaic effect)
- Suitable for recording not only images but also text
- Various steps in Forward Playback Speed (X1/16, X1/8, X1/4, X1/2, X2, X4, X16, X32, X64)
- Various steps in Backward Playback Speed (X1/16, X1/8, X1/4, X1/2, X2, X4, X16, X32, X64)
- Easy and convenient search by Jog Shuttle & Remote Controller

#### Data Back-Up

- Simple Back-Up using built-in CD Writer (Back-up CD Player included in the package)
- Network Back-Up using Remote Viewer program(Remote Viewer included in the package)
- Supports bigger capacity of HDD (300GB or bigger)

#### Others

- Multi-Language (English, Spanish, Portuguese, German, French, Italy, Japan, China)
- VGA option board supports both TFT LCD monitor and CRT monitor
- Lock the system by Password
- JOG / SHUTTLE
- PAL/NTSC Auto detection
- Control the unit by using Remote Controller

Stand-alone DVR

1-2. Package Contents

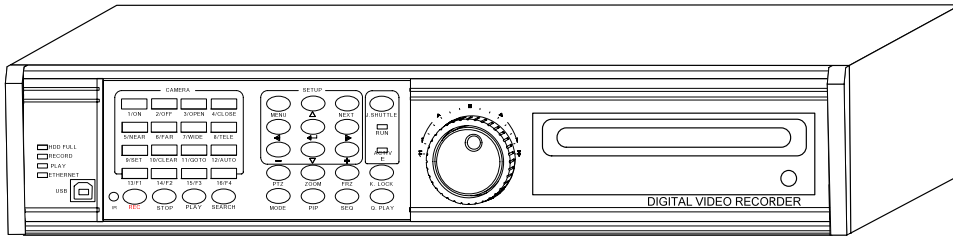

1. DVR Main Unit

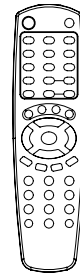

2. Remote Controller

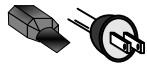

3. Power Cable

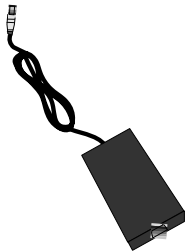

4. Power Adapter

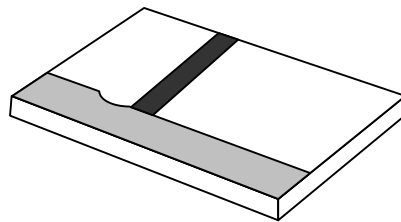

5. User's Manual

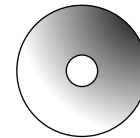

6. Software CD

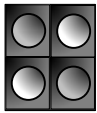

7. Rubber Pad

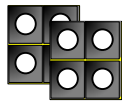

8. HDD absorber



9. Battery for remote controller

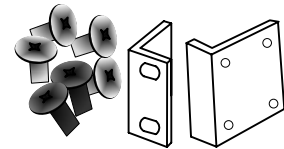

10. Bolts

Package Contents	Description
1. DVR Main Unit	STAND-ALONE DIGITAL VIDEO RECORDER
2. Remote Controller	DVR control
3. Power Cable	AC power supply to adapters for 12 V DC power
4. Power Adapter	12 V DC power supply
5. User's Manual	User's Manual
6. Software CD	Remote Viewer Software & Back up CD player
7. Rubber Pad	Prevent DVR from slipping. Attach it to the bottom of main unit
8. HDD absorber	Absorbing the mechanical shock of HDD against the case bottom
9. Battery	Battery for remote controller
10. Rack mount bracket / Bolts	Rack mount bracket
	For fixing Rack Mount bracket to DVR (6ea)
	For fixing DVR with Rack Mount bracket to 19" Rack (4ea)
	For fixing Hard Disk Drive into DVR (8ea)

CHAP. 2 Function of Each Button

2-1 FRONT

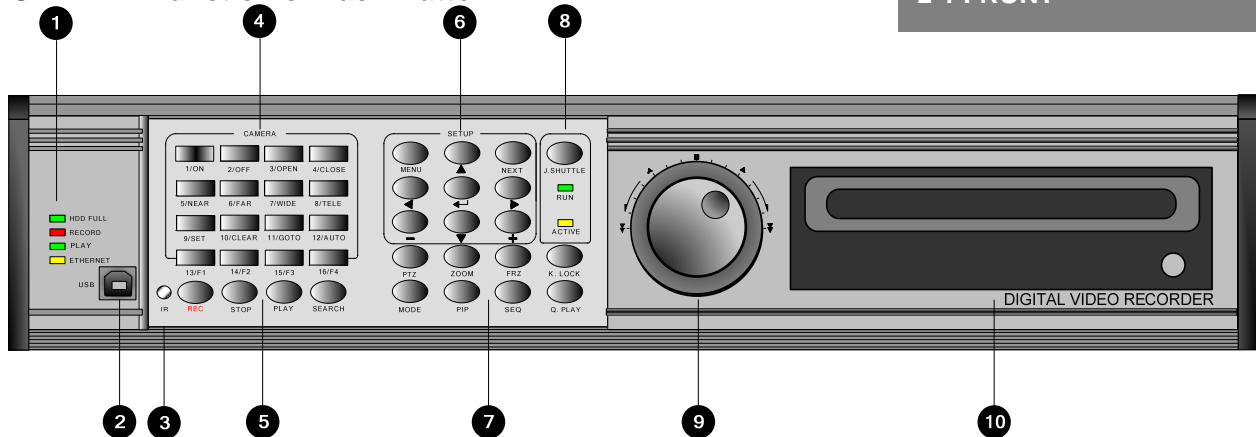

Name	Function	
① LED Lamps	Shows status of operation	
② USB Device	Firmware upgrade by connecting PC with latest firmware to USB port	
③ IR	IR receiver	
④ Camera selection & PTZ camera control	1. Pressing this button will display a full screen image of that camera	
	2. Control PTZ camera (Each button is assigned for each PTZ command)	
	• ON : LIGHT ON	• SET : SET PRESET
	• OFF : LIGHT OFF	• CLEAR : CLEAR PRESET
	• OPEN : IRIS OPEN	• GOTO : GOTO PRESET
	• CLOSE: IRIS CLOSE	• AUTO : AUTO SCAN
	• NEAR : FOCUS NEAR	• F1 : USER 1
	• FAR : FOCUS FAR	• F2 : USER 2
⑤ Record / Playback	REC	Emergency Record at continuous, 120ips, SUPER FINE size
	STOP	Stop of Emergency Record and return to Schedule Record from Emergency Record. Playback stop.
	PLAY	Playback of recorded data on HDD
	SEARCH	Search recorded data on HDD
⑥ SETUP	MENU	Set up for SYSTEM MENU or Use to exit the menu Press MENU button before powering off the unit.
	ENTER	Selects each menu option
	NEXT	Move to next step
	▲▼▶◀	Navigate in the menu
	+ -	Reduce or increase the option value in the menu

Name	Function	
⑦ LIVE View Control	PTZ	On/Off for PAN/TILT/ZOOM control mode Press this button first to control PTZ camera connected to DVR unit via RS-485
	ZOOM	Zooming an image
	FRZ	Freezing an image
	MODE	Switch to split display MODE button changes screen-division from (to) full screen to (from) 16-split screen.
	PIP	Display in PIP (Picture in Picture) mode
	SEQ	Auto camera image sequencing in full screen mode
	K.LOCK	Lock the key function. To unlock, press longer time (for several seconds) and then input the password.
	Q. Play (Quick Play)	Play from image recorded 2 minutes ago in forward direction. (in case recorded in continuous mode)
⑧ Jog Shuttle Control	J/SHUTTLE	Pressing Jog Shuttle button (Ready for use Jog/Shuttle) : In playback mode, pressing J. SHUTTLE button make images frozen.
		RUN LED on : While you operate Jog or Shuttle
		ACTIVE LED on : When J. SHUTTLE button is pressed
⑨ Jog Shuttle	Very easy and convenient search : Press J. Shuttle button, and images in playback pause, and then Jog and Shuttle makes it very easy and convenient to search, forward or backward, fast and slow, as user want.	
⑩ CD-RW	Data Back-up and Firmware Upgrade using built-in CD writer	

2-2. REAR

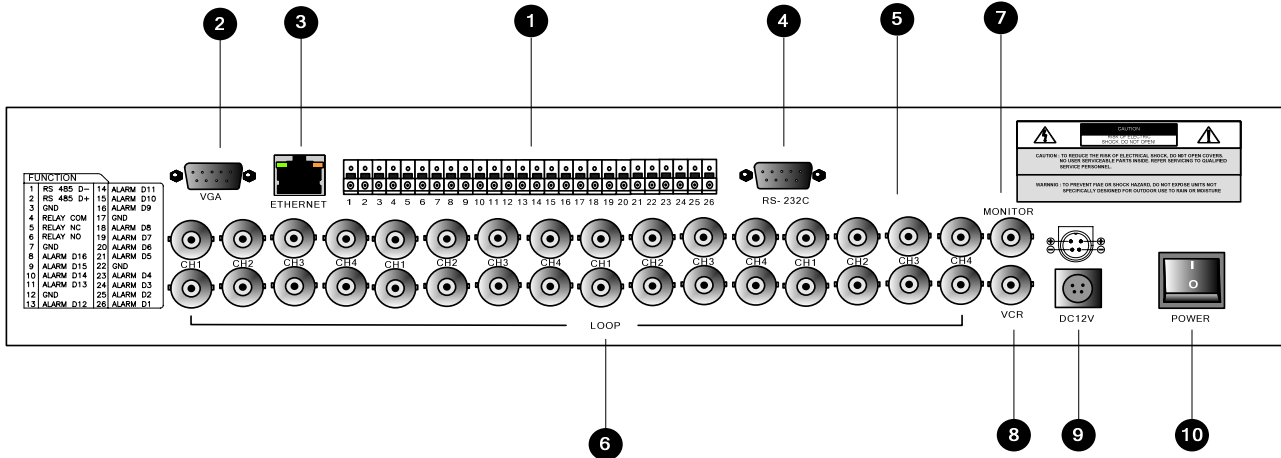

	Name	Function
1	RS 485	Connection with PTZ Camera or other external device using RS 485 interface
	RELAY Output	Relay out terminal
	SENSOR Input	Sensor input terminal
2	VGA	Connection to VGA Monitor (CRT type or TFT LCD monitor) Just in case you purchased DVR with VGA option board fixed on the main board of DVR, you can connect VGA Monitor to DVR unit.
3	ETHERNET	Connection to ETHERNET device
4	RS-232C	Connection to external device as PC using RS-232C to control the DVR
5	CAMERA Input	Connection with camera
6	LOOP Output	Camera loop out
7	MONITOR Output	Connection with Composite Monitor
8	VCR Output	Connection with VCR for analog backup
9	DC Power	DC 12V 8.3A Adaptor (Refer to the Instruction for adaptor by HDDs capacity)
10	POWER SWITCH	Power ON/OFF switch for adapters  To avoid accidental deletion of HDD data, please make sure to press MENU button before powering off the unit. This takes the unit out of record mode for safe shutdown.

### CHAP.3 Installation

#### 3-1. Installation Configuration

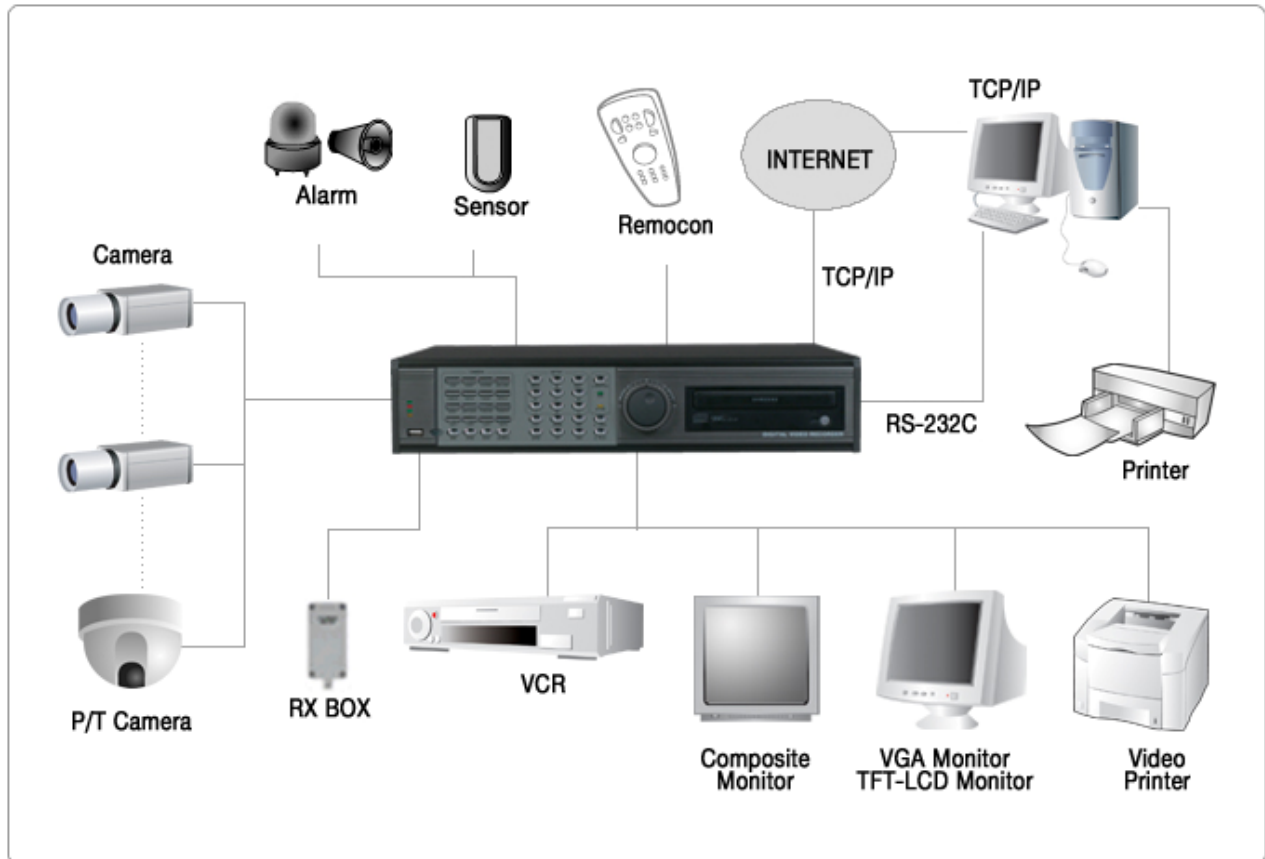

### 3-2. Detailed Installation

#### 1) Rack mount

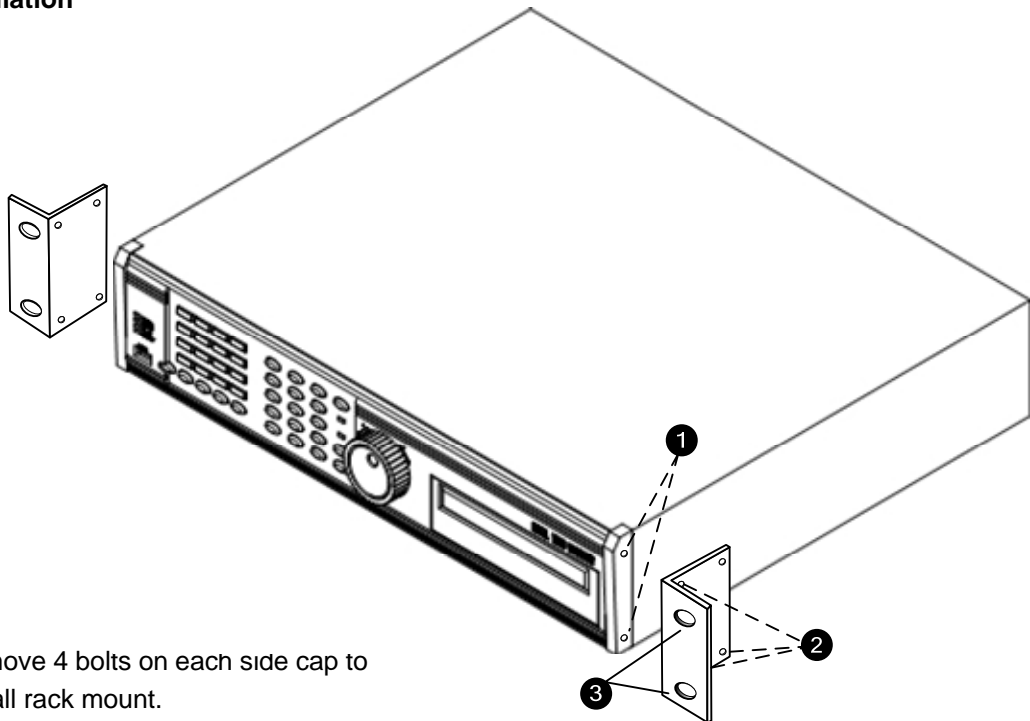

1. Remove 4 bolts on each side cap to install rack mount.
2. Attach rack mount bracket to DVR.
3. Attach DVR with rack mount bracket to 19" rack.

#### 2) HDD

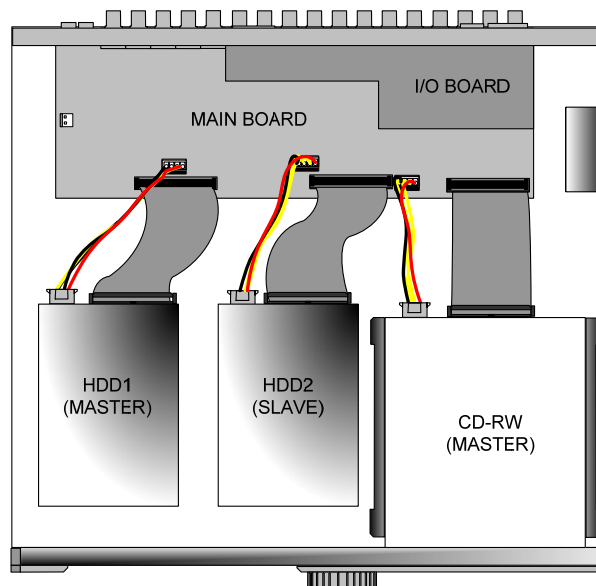

1. Connect Main Board and HDD1 using IDE cable and HDD power cable.
2. The jumper setting of HDD1 should be on Master if you install only one HDD.
3. The jumper setting of HDD1 should be on Master and HDD2 should be on Slave if you install two HDDs.(Refer to the above figure)
4. Stick the HDD absorber (included in package) on the bottom of case and then install the HDD on top of them by using the bolts (included in package).
5. Screws must be inserted from outside of the case bottom.

Stand-alone DVR

3) Camera

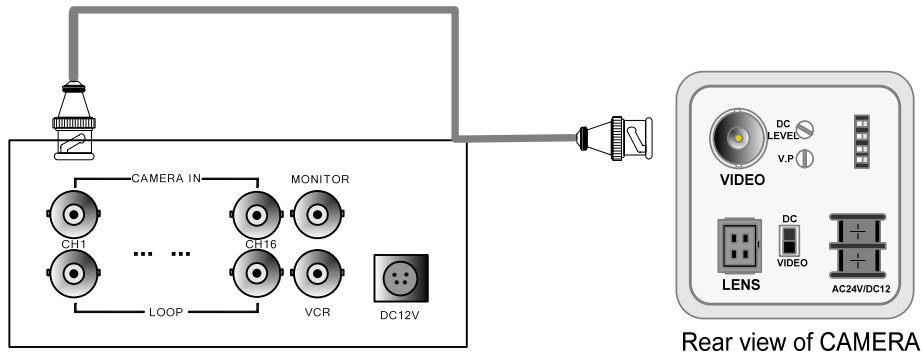

Connect cameras to the camera input on rear panel of DVR marked CAMERA IN.

4) Monitor

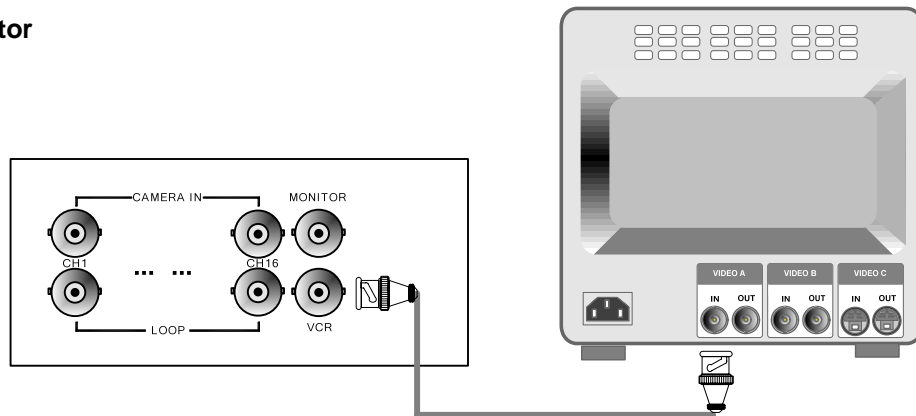

Connect the video output marked MONITOR to Video-In of Main monitor.

5) Power

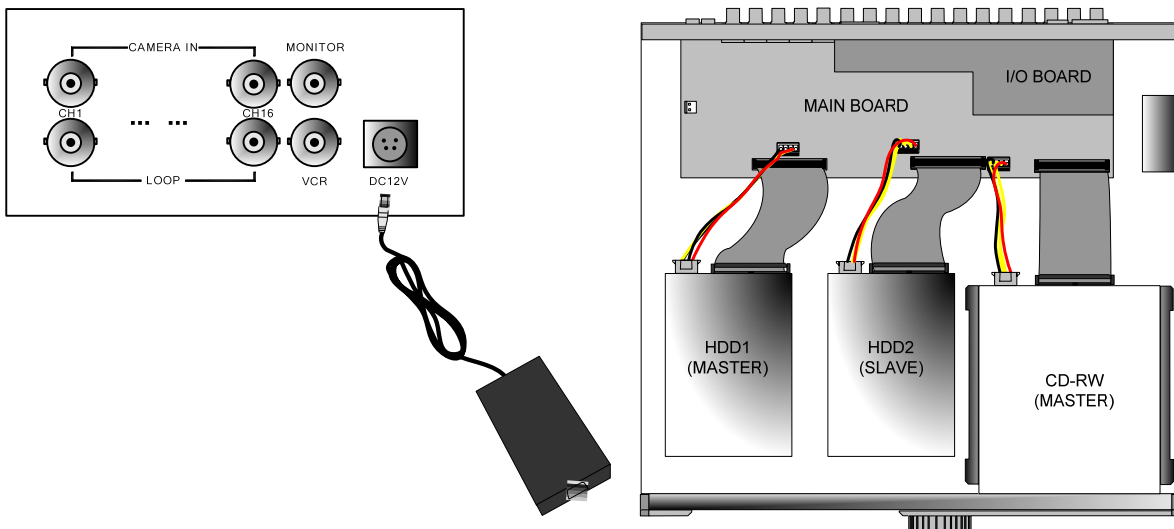

Connect one DC 12V, 8.3 A Adaptor to the back side of Power Jack for right operation of 2HDDs and CDRW.



Before you turn on the Power switch, be sure all necessary devices such as Power adaptor, cameras and Monitor are connected properly to DVR!

**Notice**

To avoid accidental deletion of HDD data, please make sure to press MENU button before powering off the unit. This takes the unit out of record mode for safe shutdown.

6) VCR, VIDEO PRINTER

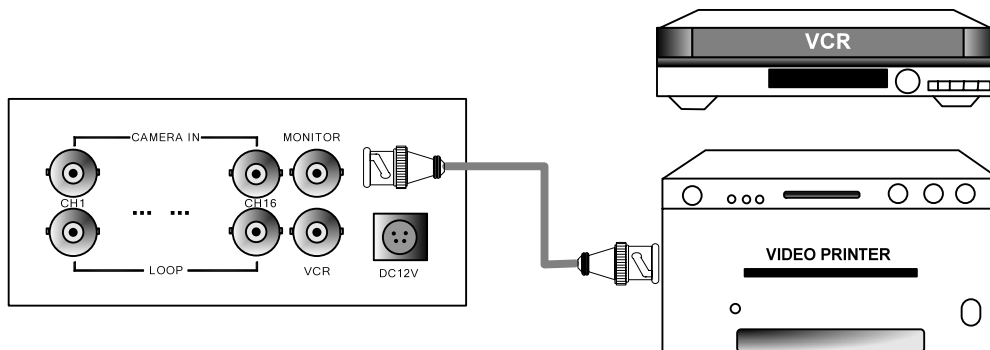

Connect VCR or VIDEO Printer to VCR out on the rear panel of DVR.

7) Other External Device

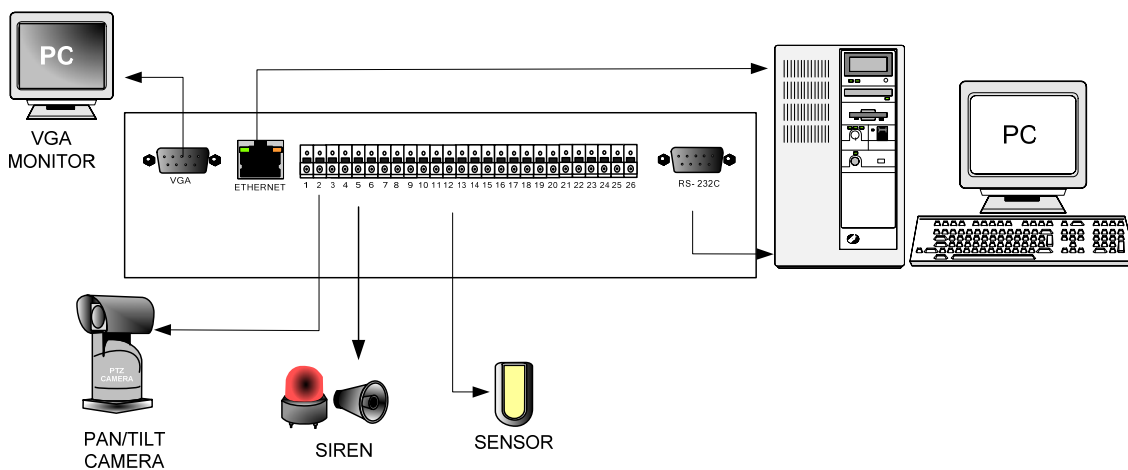

**RS-232C** : Control DVR through RS-232C port by using PC.

**RS-485** : Control external device like PTZ Camera

**RELAY Output** : Relay Output

**SENSOR Input** : SENSOR Input (Alarm connection)

**ETHERNET** : Connection to LAN, WAN, Internet.

**VGA** : Connection to a VGA monitor(CRT,TFT LCD) if optional VGA board is fixed on the main board as shown in the following figure.

Resolution set by manufacturer is 800x600 60 Hz, and user can set resolution in MONITOR SETUP / VGA SETUP / VGA RESOLUTION.



### 8) Connector Pin Assignment

No		Description	NO		Description
1	DCD	Data Carrier Detect	6	DSR	Data Set Ready
2	RxD	Receive data	7	RTS	RS232C: Rx/Tx data
3	TxD	Transmit data	8	CTS	RS232C: Rx/Tx data
4	DTR	Data Terminal data	9		
5	GND	Signal Ground			

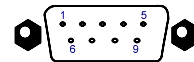

RS-232C

### 9) RS-232C ASCII-code

Following ASCII-Codes(Hexa-Code) are for programmers who want to control DVR unit via the RS232C Port using keyboard of PC.  
(The following table is based on 16ch DVR.)

All ASCII-Code is 1 Byte.

REC	'R'	DOWN	'J'	PTZ	'T'	KLOCK	'C'	CH6	'6'	CH13	'#'
STOP	'S'	LEFT	'H'	ZOOM	'Z'	QPLAY	'Y'	CH7	'7'	CH14	'\$'
PLAY	'P'	RIGHT	'K'	FRZ	'F'	CH1	'1'	CH8	'8'	CH15	'%'
Pause	'A'	NEXT	'N'	MODE	'D'	CH2	'2'	CH9	'9'	CH16	'^'
SERCH	'E'	ENTER	0x0d	PIP	'I'	CH3	'3'	CH10	'0'		
MENU	'M'	-	'<'	SEQ	'Q'	CH4	'4'	CH11	'!'		
UP	'U'	+	'>'	J.SHU	'L'	CH5	'5'	CH12	'@'		

### Jog / Shuttle

Please input 'L' command to activate J/SHUTTLE function using keyboard of PC.

Shuttle Right 10 degree	"&<1"[enter]	Shuttle Left 10 degree	"&>1"[enter]
Shuttle Right 20 degree	"&<2"[enter]	Shuttle Left 20 degree	"&>2"[enter]
Shuttle Right 30 degree	"&<3"[enter]	Shuttle Left 30 degree	"&>3"[enter]
Shuttle Right 40 degree	"&<4"[enter]	Shuttle Left 40 degree	"&>4"[enter]
Shuttle Right 50 degree	"&<5"[enter]	Shuttle Left 50 degree	"&>5"[enter]
Shuttle Right 60 degree	"&<6"[enter]	Shuttle Left 60 degree	"&>6"[enter]
Shuttle Right 70 degree	"&<7"[enter]	Shuttle Left 70 degree	"&>7"[enter]
		Shuttle Left 80 degree	"&>8"[enter]
Jog Minus	"&-"[enter]	Jog Plus	"&+"[enter]

Shuttle : After inputting a command once, it will keep performing the command until next command.

Jog : It makes the stage staying after one time operation by command input like Button operation.

#### 4-1. System Log-In

- 1) To enter into the setup menu, press the [MENU] button.
- 2) Enter password with channel number button from No.1 to No.10 on the front of the DVR unit. (Maximum of 8 digits are available)
- 3) After inputting the password, press the [ENTER] button.

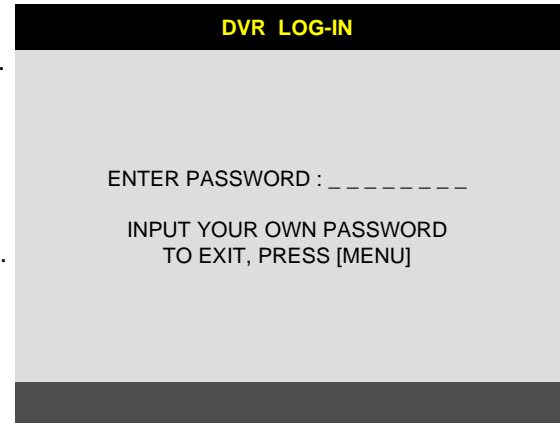

Administrator :

If the password entered matches previously set password, "LOGIN ADMIN" message appears and you can enter into SYSTEM SETUP.

If the password entered does not match previously set password, the DVR unit goes back to live display mode.

Factory default password is blank. For log-in, just press [MENU] button and then [ENTER] button.

-Factory default password  
 ADMIN : (Blank)  
 MANAGER : ' 1 '  
 USER 1~USER8 : ' 2 ' ~ ' 9 '

※ We recommend configuring a unique password as per the procedure in SYSTEM MENU - CONFIGURATION - PASSWORD SETUP.

※ For security reasons, be sure to make note of your own password.

#### 4-2. Factory Default

Before first operation, you must set Time/Date, set FACTORY DEFAULT, and then clear HDD, even though it is brand new one. It is to make DVMR system and HDD ready for proper operation. Starting recording without FACTORY DEFAULT setting and HDD clear will cause malfunction.

##### 1. HDD CLEAR

DISPLAY SETUP  
 CONFIGURATION  
 REOCRD SETUP  
 BACK-UP  
 EXTERNAL DEVICE  
 FACTORY DEFAULT  
 LANGUAGE

Refer to page 22.

HDD MANAGEMENT  
 TIME/DATE SETUP  
 CAMERA SETUP  
 INTERVAL SETUP  
 ALARM SETUP  
 BUZZER SETUP  
 PASSWORD SETUP  
 SYSTEM INFORMATION

##### 2. FACTORY DEFAULT

DISPLAY SETUP  
 CONFIGURATION  
 REOCRD SETUP  
 BACK-UP  
 EXTERNAL DEVICE  
FACTORY DEFAULT  
 LANGUAGE

Refer to page 31.

### 4-3. Display Configuration

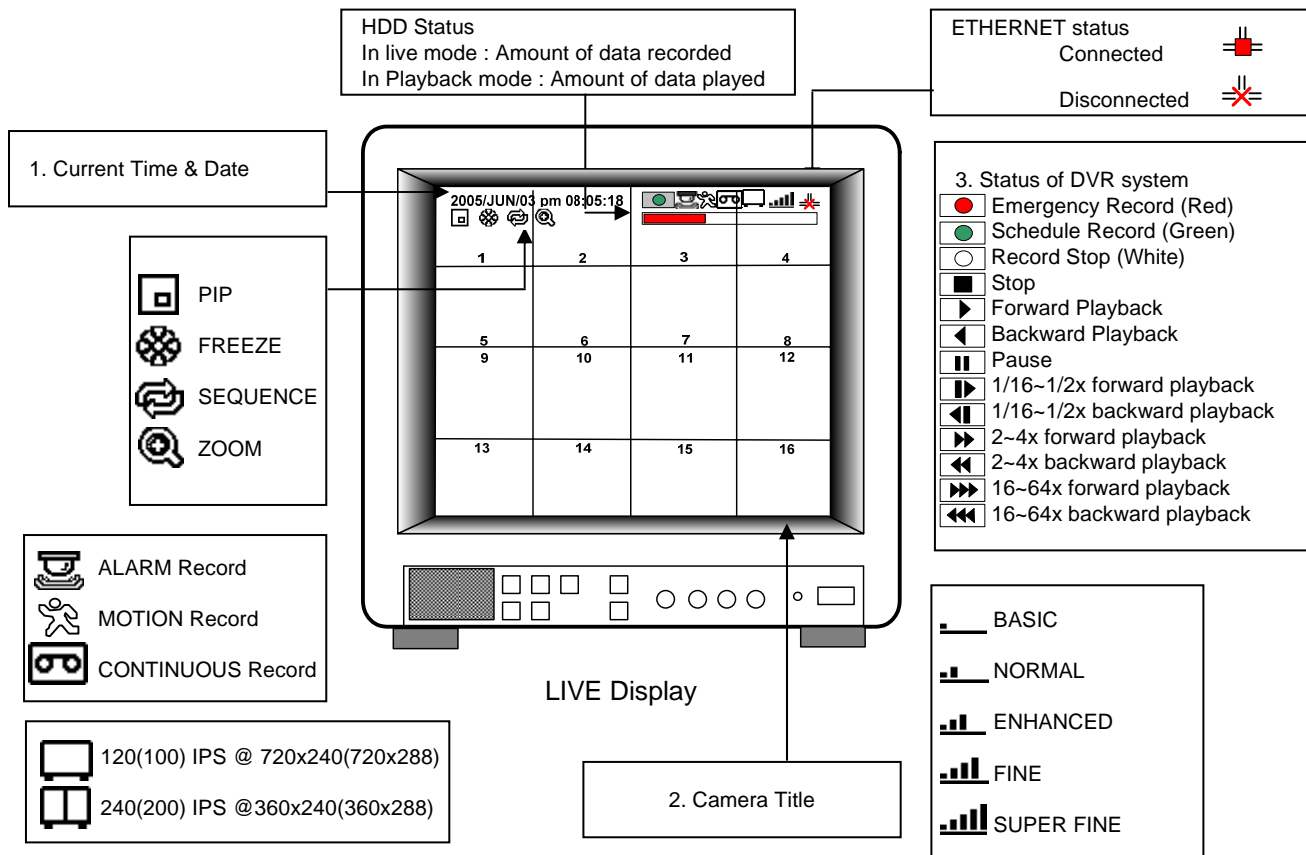

### 4-4. Live View Setup

#### 1) Full / Multiple View

Switch to multi-screen display by pressing [MODE]. For full image display, just press the channel button which you want or continue to press [MODE] button until you see full screen.

When you playback images which recorded in 360X240(360X288) resolution, only 4,9,13 & 16 split screens are available.

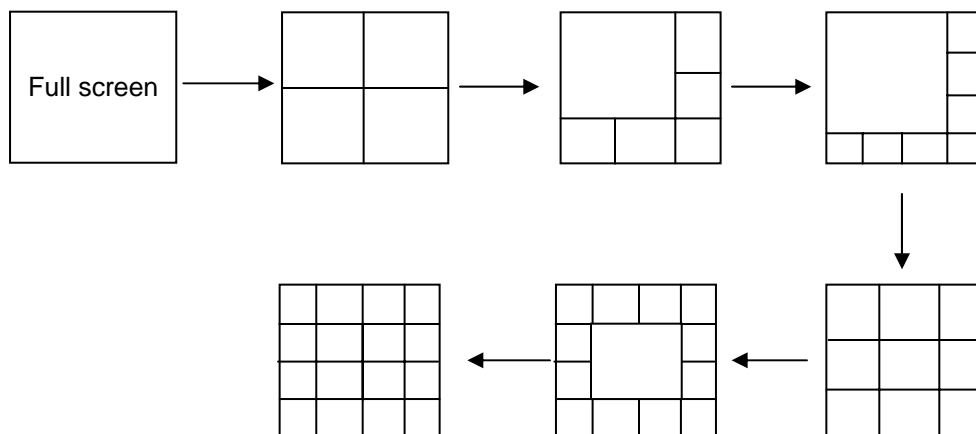

Multiple screen changes

## 2) View in Sequence

Press [SEQ] button. It automatically displays full screen images in sequence.

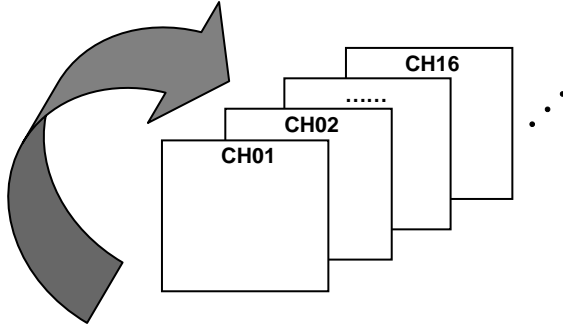

## 3) Picture in Picture(PIP View)

When it is in full screen display mode, you can see other camera in a small window by pressing [PIP]. The other camera in small window is rotating in sequence to next number of camera and you can set the rotating time interval as per the procedure in SYSTEM MENU-CONFIGURATION-INTERVAL SETUP.

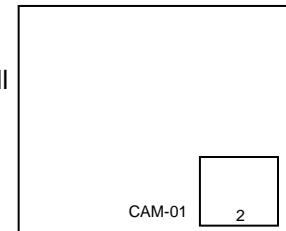

## 4) Freeze View

**Full display mode :** If you press the [FRZ] button, the FRZ icon will be activated on the screen and "F" character will be shown beside camera title, and live image will be frozen.

**Split display mode :** If you press the [FRZ] button, the FRZ icon will be activated on the screen. press the channel button which you want to freeze.  
To release frozen image, press channel number of frozen image again and press [FRZ] button to exit FRZ mode.

## 5) Zoom View

In full screen, press the [ZOOM] button and move the Selection Frame using J.SHUTTLE or Direction keys to the area which you want to enlarge. And then press the [ENTER] button for 2-times enlarged picture. To exit Zoom mode, just press [ZOOM] button again.

Horizontal Movement : J.SHUTTLE



Vertical Movement : Hold [UP or DOWN] button and turn J/SHUTTLE

## Stand-alone DVR



**4-5. Record**

Recording mode set before delivery by manufacturer (Default recording mode) is Schedule Recording. In this default recording mode, it records 24 hours/day continuously in weekday and on the weekend. Once you press the [REC] button while you see live view, the record type is changed to Emergency Record mode.

- Emergency Record : at full resolution/in best quality  
Record type : CONTINUOUS, SUPER FINE quality,  
120 (100) ips at 720X240 (720x288)
- Schedule Record  
Record and stop as set (time interval and record type) in RECORD-SCHEDULE SETUP menu.
- Stop Record  
Recording stopped as set in RECORD-SCHEDULE SETUP menu.

-  Emergency Record [RED]
-  Schedule Record [GREEN]
-  Stop Record [WHITE]

**On the screen**

- Emergency Record  
: Red Record Icon (  ) and Record LED is lit
- Schedule Record  
: Green Record Icon (  ) and Record LED is lit
- Record Stop  
: White Icon (  ) and Record LED is off
- Motion Record, Alarm Record, Alarm+Motion Record  
: Record standby LED blinks  
: Record LED is lit
- ※ While in Emergency Record mode, press [STOP], [PLAY], [MENU], or [SEARCH] button to exit from Emergency Recording mode and return to Schedule Record mode.
- ※ For details, refer to the SYSTEM MENU – RECORD SETUP (Page 27)

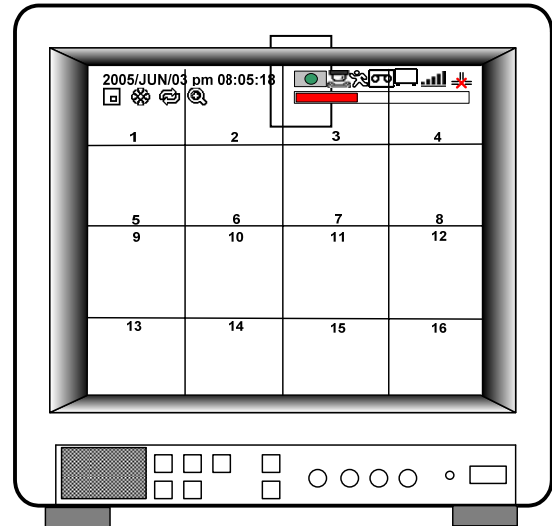
**- This DVR unit does not record in following conditions ;**

- ※ While entered in the Menu.
- ※ No camera is connected
- ※ Overwriting is off in the Record Setup menu.

**4-6. Playback**

On record mode or stop mode, press [PLAY] button to play the recorded data in 1x speed. For backward playback, press [PLAY] button again. Use Jog/Shuttle to pause and control playback speed. To stop playback, press the [STOP] button.

**Using Jog/Shuttle**

press the [J.SHUTTLE] button in playback mode. The [ACTIVE] LED will be lit, and Jog/Shuttle is ready for use. The [RUN] LED will blink whenever you operate the Jog/Shuttle. For forward playback, turn the Shuttle right and turn Shuttle left for backward playback. Turn Jog using your index figure to see picture by picture in forward or backward direction. Operation of Shuttle is as follows.

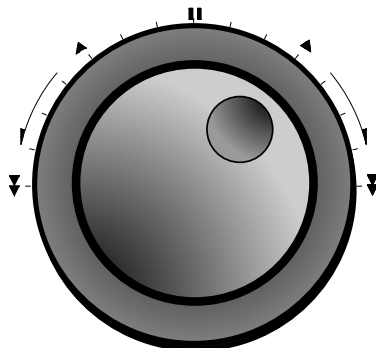
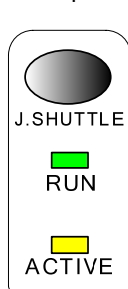

- 1/4 x : 4 times slower than normal playback speed
- 1/2 x : 2 times slower than normal playback speed
- 1 x : Normal playback speed
- 2 x : 2 times faster than normal playback speed
- 4 x : 4 times faster than normal playback speed
- 16 x : 16 times faster than normal playback speed
- 64 x : 64 times faster than normal playback speed

If you want to keep the playback speed you selected using Shuttle, just hold the shuttle at that location for a few seconds, and playback in speed you selected continues until you rotate Shuttle again.

### 4-7. Search

Press [SEARCH] button, and 3 different methods for searching recorded data are available as shown in following SEARCH window. For selecting searching method, use direction key or Jog/Shuttle. After selecting each search method, press [ENTER] button for playback. exit, press [MENU] button.

1) SEARCH BAR

Search by percentage of total recorded data. It starts from image corresponding to set % of data on the search bar.

2) TIME/DATE

Search by time & date. Playback starts from the time & date selected.

3) EVENT LIST

Search by event list (Motion, Alarm, Video Loss).

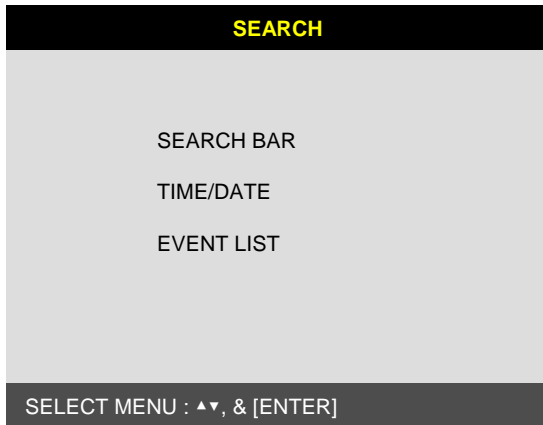

SEARCH page

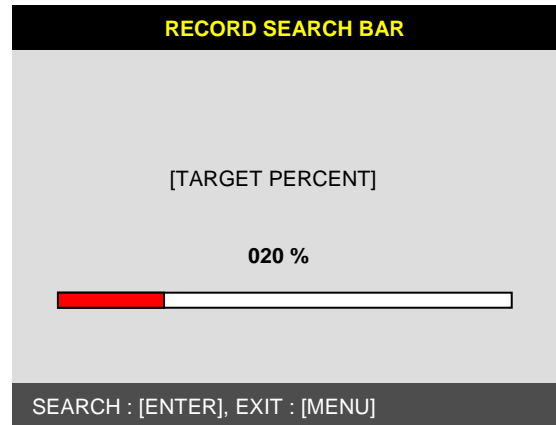

SEARCH BAR page



TIME/DATE page

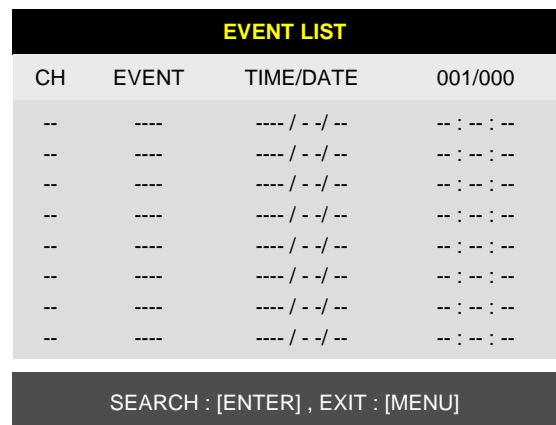

EVENT LIST page

## Stand-alone DVR

**4-8. PAN/TILT/ZOOM Camera Operation**

Press [PTZ] button first for PTZ control mode. Numeric buttons from 1 to 16 and direction buttons are assigned for each PTZ command, and user can control PTZ camera connected to DVR unit by pressing any one of those 20 buttons, one after the other, as needed, and it is just like control by separate PTZ controller.

Button	PTZ command	Button	PTZ command
1/ON	LIGHT ON	10/CLEAR	PRESET CLEAR
2/OFF	LIGHT OFF	11/GOTO	PRESET GOTO
3/OPEN	IRIS OPEN	12/AUTO	PRESET AUTO
4/CLOSE	IRIS CLOSE	13/F1 ~ 16/F4	FUNCTION
5/NEAR	FOCUS NEAR	UP BUTTON	TILT UP
6/FAR	FOCUS FAR	DOWN BUTTON	TILT DOWN
7/WIDE	ZOOM IN	LEFT BUTTON	PAN LEFT
8/TELE	ZOOM OUT	RIGHT BUTTON	PAN RIGHT
9/SET	PRESET SET		

**4-9. Data Back-Up**

Enter into SYSTEM MENU-BACKUP-CDR SETUP.

- 1) Insert empty CD-R media into CD writer and select the start time & date from which you want to back up.
  - ⊗ The START & END time / date in HDD sub-menu only shows start and end of recording. This is not selectable and editable.
  - ⊗ 700MB on CD-R sub-menu represent size of CD-R media inserted.
- 2) To set start time of back-up and back-up data size, press the [ENTER] button first on [START] or [SIZE] sub-menu and adjust using [+] or [-] button and move using [LEFT] and [RIGHT] button for next change. After setting the time & date and back-up data size, press the [ENTER] button again to exit.
  - ⊗ End of back-up time will be calculated automatically as per start time & date and the back-up data size you set.
  - ⊗ User can select the back-up data size (size of back-up data from start of back-up) on [SIZE] item but END of back-up time is automatically determined by DVR system.
- 3) Press [ENTER] button on BURN sub-menu. DVR system starts burning CD.
- 4) When burning is completed, CD-R media will come out automatically. In the next CD back-up, start time of CD-R shall be the end time of previous CD-back-up, and you can back-up from that for continuous data back-up. If you need another backup, repeat the above procedure. To stop backup, press the [MENU] button.
  - ⊗ During burning CD, it's impossible to cancel burning process.
- 5) User can verify the back-up CD on PC with BACK-UP CD PLAYER (Included in Package).

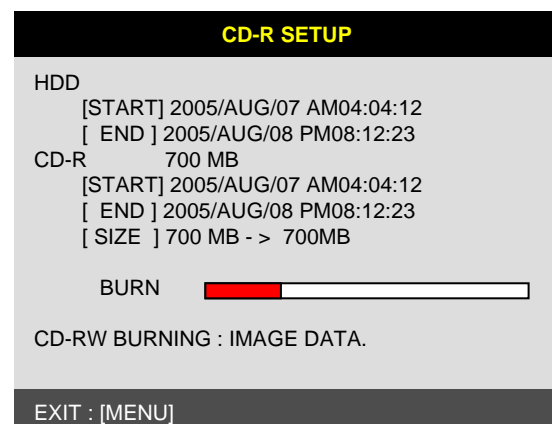
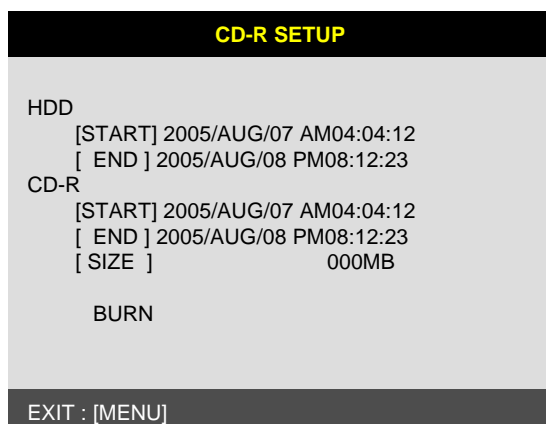

## CHAP. 5 Set Up

### 5-1. Entering into the Menu

Enter into SYSTEM MENU by pressing [MENU] button.

Button	Function
MENU	Enter into SYSTEM MENU, Move to previous menu, ESC
ENTER	Selection key, Move to sub-menu, change status (ON or OFF)
NEXT	Move to next page
UP	Move to upper side
DOWN	Move down side
LEFT	Move to the left
RIGHT	Move to the right
MINUS [-]	Decrease the option value
PLUS [+]	Increase the option value
Jog Shuttle	Jog left turning : Move backward to next image / Decrease value Jog right turning : Move forward to next image / Increase value
	Shuttle left turning : Decrease playback speed / Decrease value Shuttle right turning : Increase playback speed / Increase value

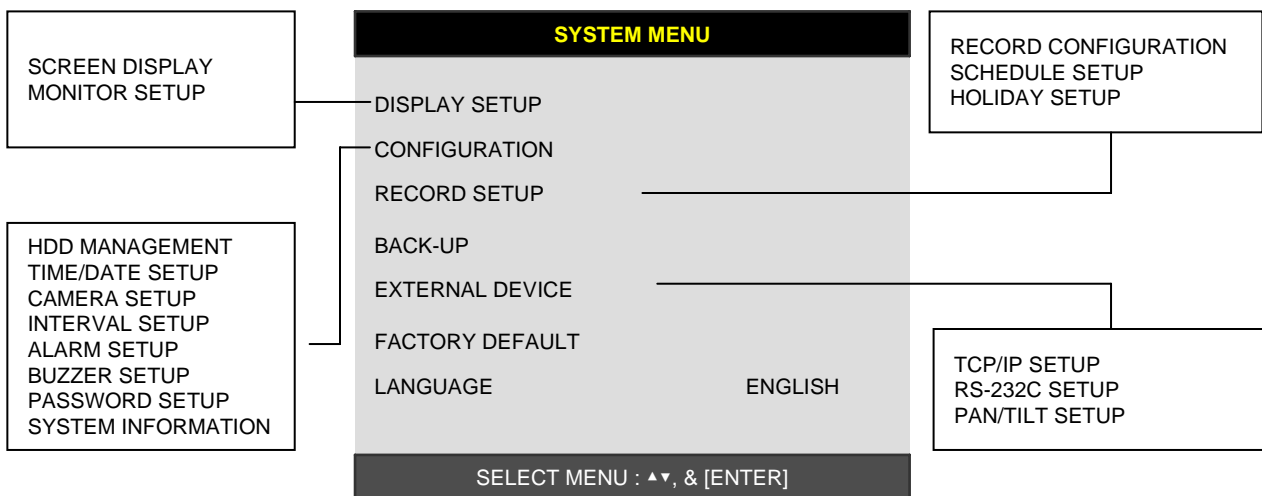

### SYSTEM MENU

## 5-2. DISPLAY SETUP

Setting up parameters for monitor and display on screen.  
Enter into SYSTEM MENU-DIPLAY SETUP.

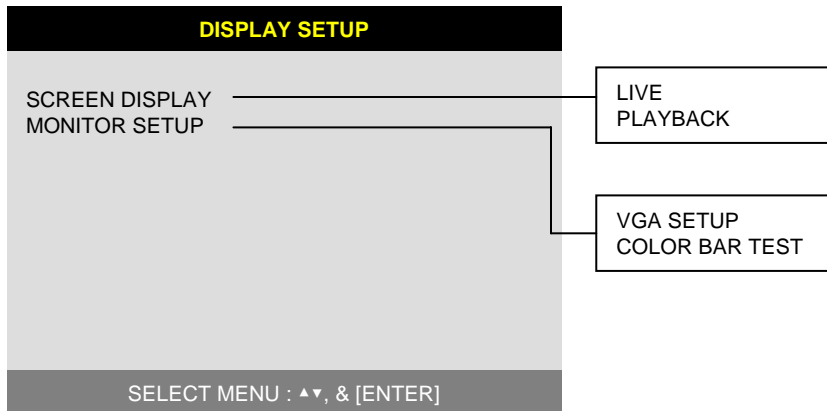

### 1) SCREEN DISPLAY

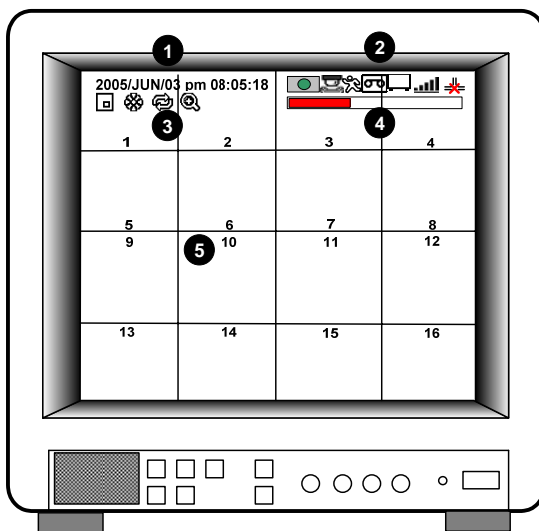

Setting up the screen display in LIVE mode and PLAYBACK mode.

Select the sub-menu which you would like to set using direction buttons and then change ON/OFF with [ENTER] button.

1. TIME/DATE : Display time & date
2. DVR STATUS : Display system setting status
3. ICON DISPLAY : Display function setting status
4. REC/PLAY BAR : Display record / playback status
5. CAMERA TITLE : Display camera title

### 2) MONITOR SETUP

**VGA SETUP :** VGA option card enables to connect TFT LCD monitor or CRT type PC monitor to DVR unit. To connect TFT LCD monitor or CRT type PC monitor to DVR unit, select resolution as follows using [+] or [-] button. After setting the below option, press [ENTER] button then the DVR unit will set VGA resolution automatically.

VGA option card supports following resolution, and choose best resolution that match TFT LCD monitor or CRT type PC monitor to be connected to DVR unit.

- 640X480 / 60Hz
- 800x600 / 60Hz
- 1024X768 / 60Hz
- 640X480 / 75Hz
- 800X600 / 75Hz
- 1024X768 / 75Hz

※ **NOTICE :** In the booting process, DVR unit with VGA option card takes some seconds more to set parameters.

**COLOR BAR TEST :** Adjust color tone of monitor.

(Color bar test is Not available for monitor through VGA)

### 5-3. CONFIGURATION

Various parameters for system can be set in CONFIGURATION menu.  
Enter into SYSTEM MENU-CONFIGURATION and press the [ENTER] button.

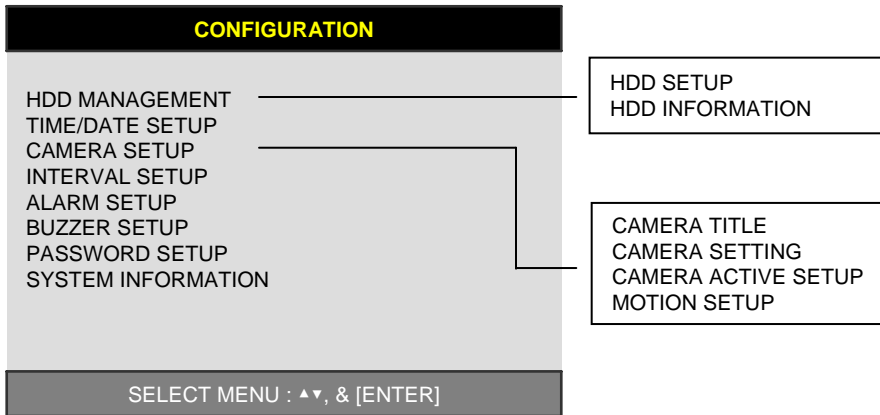

#### 1) HDD MANAGEMENT

Enter into SYSTEM MENU-CONFIGURATION-HDD MANAGEMENT and press the [ENTER] button.

##### (1) HDD SETUP

This page includes information about start and end of recording, location of recorded data, or location of last playback on HDD. In addition, users can delete all the data on HDD.

HDD SETUP		
STATUS	HDD	DATE/TIME
BEGIN	MASTER	2005/04/08 12:12:05
RECORD	MASTER	2005/04/09 15:09:58
PLAY	MASTER	2005/04/08 19:44:31
HDD STATUS		NORMAL
HDD CLEAR		IN USE →

HDD CLEAR [ENTER], EXIT [MENU]

On the [HDD CLEAR] sub-menu, press the [ENTER] button to delete all image data on HDD. The system will ask password for verification. After you clear all data on HDD, status of HDD CLEAR changes from IN USE to EMPTY.  
※ When you clear HDD, event list is deleted, too.

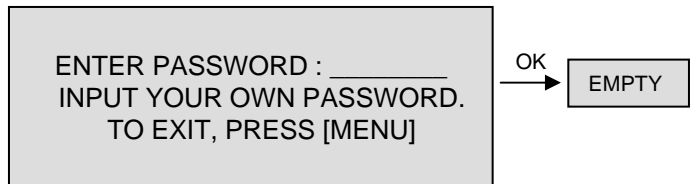

If you selected OVERWRITE in Record Setup, the HDD STATUS presented as OVERWRITE.

##### (2) HDD INFORMATION

This menu will show the physical information of HDD in DVR.

HDD INFORMATION	
[MASTER]	
MODEL	: Maxtor 6Y080L0
SPEED	: PIO-4
SIZE	: 81,964,302,336 BYTES
START	: 2005/04/08 12:08:56
END	: 2005/04/08 12:08:56
[SLAVE]	
MODEL	: AT5520026DT
SPEED	: 240/120nsec
SIZE	: 80GB
START	: 2005/04/08 12:08:56
END	: 2005/04/08 12:08:56

TO EXIT, PRESS [MENU]

### 2) TIME/DATE SETUP

Set time and date of DVR system which is very important for search with time and date of the event. Time and date set by manufacturer is different from local time of user, and user must set time and date exactly in the first operation. Set time & date using direction buttons and [-][+] button or Jog shuttle

**TIME/DATE SETUP**

YEAR	
MONTH	2005 / JUN /11
DAY	
HOUR	PM14:06:45
MINUTE	
SECOND	

SELECT : ▲▼, CHANGE VALUE : - +

### 3) CAMERA SETUP

**CAMERA SETUP**

CAMERA TITLE  
 CAMERA SETUP  
 CAMERA ACTIVE SETUP  
 MOTION SETUP

SELECT MENU : ▲▼, & [ENTER]

**CAMERA TITLE SETUP**

0123456789 .ABCDEFGHIJKLMNPQ  
 RSTUVWXYZ ! # - [ ] \* + - , / : <=> ? @ ▶ ◀

CAMERA01	CAM -1
CAMERA02	CAM -2
CAMERA03	CAM -3
CAMERA04	CAM -4
CAMERA05	CAM -5
CAMERA06	CAM -6
CAMERA07	CAM -7
CAMERA08	CAM -8

[ENTER] SELECT MODE  
[▲/▼] select CAMERA

(1) TITLE : Input Title of each camera. Move to channel you want to change using [LEFT] or [RIGHT] direction button and then change the title using [-] [+] button. When modification is finished, press the [ENTER] button. To exit to previous menu, press the [MENU] button.

(2) COLOR : Adjust image color  
 Move to each element using [UP][DOWN] button and adjust using [-] [+] button or Jog shuttle.

CHANNEL : Select camera  
 BRIGHTNESS : Adjust image brightness (-32~ 31)  
 CONTRAST : Adjust color contrast ( -32 ~ 31)  
 SATURATION : Adjust color saturation ( -32 ~ 31)  
 HUE : Adjust color hue ( -32 ~ 31)

**CAMERA COLOR SETUP**

CHANNEL	1
BRIGHTNESS	+0
CONTRAST	+0
SATURATION	+0
HUE	+0

SELECT : ▲▼, CHANGE VALUE : + -

## Stand-alone DVR

CAMERA ACTIVE SETUP			
CH	STATUS	LIVE	REC
01	ACTIVE	ON	ON
02	ACTIVE	ON	ON
03	LOSS	OFF	OFF
04	ACTIVE	ON	OFF
05	ACTIVE	ON	ON
06	ACTIVE	ON	ON
07	ACTIVE	ON	ON
08	ACTIVE	ON	ON

SELECT : ▲▼◀▶, & [ENTER]

MOTION CONFIGURATION	
CHANNEL	01
SENSITIVITY GRADE	01
MOTION DISPLAY TYPE	OFF
RECORD DURATION	05 SEC

SELECT ▲▼, CHANGE VALUE : + -

(3) CAMERA ACTIVE SETUP : With direction button, move to option to be changed, and press [ENTER] button to select [ON/OFF]. If it is set at LIVE [OFF] and REC [ON], DVR system records, but does not show live image of set channel.

- STATUS : Shows if image from a specific channel is coming for live display and recording. In normal camera condition, it is ACTIVE, but LOSS is displayed when the cable is disconnected or camera is not working.
- LIVE : Decides whether to show LIVE screen image or not.
- REC : Decides whether to record relevant channel or not.

(4) MOTION SETUP: You can set sensitive of motion detection in 4 steps, motion detection area and others in relation to motion recording in this menu.

## (4)-1. MOTION SETUP

- SENSITIVITY GRADE : Adjusts motion detection sensitivity. (LOW, MEDIUM, HIGH, VERY HIGH)
- MOTION DISPLAY TYPE : Showing cells with motion detected differently from cells with no motion .
- RECORD DURATION : Whenever motion is detected and it is set at Motion Recording mode, DVR system records for RECORD DURATION from time motion is detected. (1sec. ~ 99 sec.) (Default duration : 5 sec.)

(4)-2. MOTION MASK SETUP: Set motion detection area. Direction button is for moving and [ENTER] button is for selection, and [MODE] button is for changing mode of MASK SETUP.

- CELL : Move to the location which you want to detect and then press the [ENTER] button. Highlighted cell area means motion detection area.
- ALL ON : Set all cells as detection area. Use [ENTER] button to set.
- ALL OFF : Set all cells as no-detection area. Use [ENTER] button to set.
- BLOCK ON : Select detection area by block. Use [MODE] button and press [ENTER] button to set ON.
- BLOCK OFF : Select un-detection area by block. Use [MODE] button and press [ENTER] button to set ON.

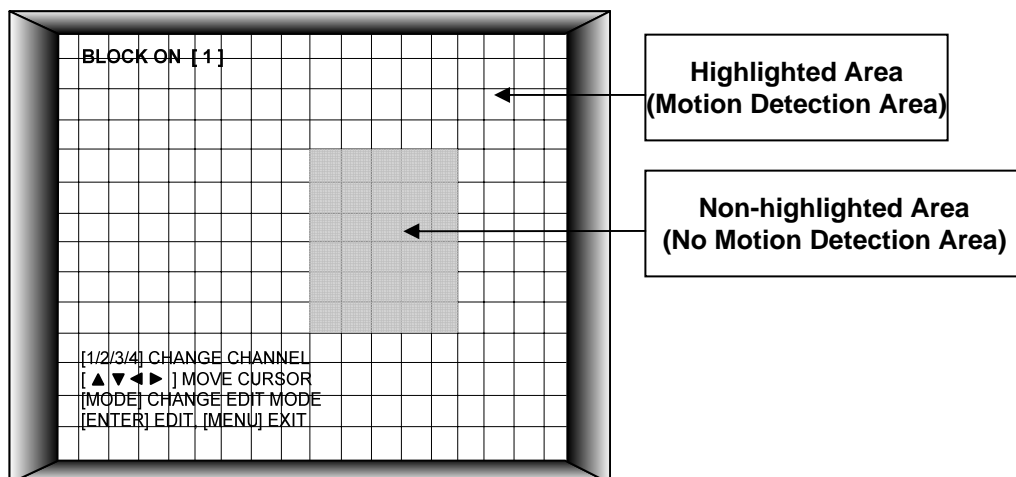

#### 4) INTERVAL SETUP

Set the switching time interval for SEQ or PIP function.(1 sec. ~ 99 sec.)

FULL SCREEN : set the sequencing switch time interval in live full screen.

PIP SCREEN : set the sequencing switch time interval of PIP window.

EVENT UPDATE TIME : Set the minimum time interval of event to be listed in EVENT LIST.  
 If EVENT UPDATE TIME is set at 20 sec, only following event happened 20 sec or more than 20 sec later previous event shall be listed in EVENT LIST.

INTERVAL SETUP	
SWICHING INTERVAL	
FULL SCREEN	: 01 SEC
PIP SCREEN	: 01 SEC
EVENT RECORD	
EVENT UPDATE TIME	: 01 SEC
SELECT ▲▼◀▶, CHANGE VALUE : +-	

#### 5) ALARM SETUP

Set type of alarm sensors connected to DVR unit.  
 N.O represents Normal Open type and N.C Normal Close type.

ALARM SETUP	
CHANNEL	CH1
ALARM INPUT	N.O
DURATION	005
N.O .....	NORMAL OPEN
N.C .....	NORMAL CLOSE
.....	DISABLE
SELECT : ▲▼, CHANGE VALUE : +-	

- 1) ALARM INPUT : Select type of alarm sensor connected to DVR unit (N.O or N.C).  
 Use direction button and [-] [+] button to set.  
 DISABLE represents not to use alarm sensor connected to DVR.
- 2) DURATION : Set the duration of alarm when an ALARM is activated. (0 sec. ~ 300 sec.)

## 6) BUZZER SETUP

Set parameters for buzzer (On or Off).  
Use direction button and [ENTER] button.

KEY BEEP : buzz when button is pressed.  
VIDEO LOSS : buzz when video signal is lost.  
ALARM ACTIVE : buzz when alarm is activated.  
MOTION DETECT : buzz when motion is detected.

User can set all buzzers at On/Off at once  
by set ALL at ON/OFF.

BUZZER SETUP	
ALL	ON
KEY BEEP	ON
VIDEO LOSS	ON
ALARM ACTIVE	ON
MOTION DETECT	ON

SELECT : ▲▼, & [ENTER]

## 7) PASSWORD SETUP

Set user ID and password.

-Use [UP] and [DOWN] button to move to option  
and [LEFT] and [RIGHT] button to set user ID.

The password must be consist of 1 to 8 digit  
number. Just use numbers button from 1 to 10  
on the front panel of DVR unit.

-To change password, user must input current  
password and then input new password.  
And input again new password to confirm.

- Default value

ADMIN : ' ' (Blank)

MANAGER : '1'

USER 1 : '2'

:

:

USER 8 : '9'

※ Change the user PASSWORD in the first operation is recommended.

※ In case you forgot PASSWORD, contact dealer of DVR to get instruction to enter into menu to  
set new PASSWORD.

PASSWORD SETUP	
USER I D	ADMIN
USER PW	-----
NEW PW	-----
CONFIRM	-----

[K1-K10] INPUT PASSWORD  
[ENTER] CHANGE PASSWORD

TO EXIT, PRESS [MENU]

## 8) SYSTEM INFORMATION

DVR system information including firmware  
version, hardware version, product ID, etc....

SYSTEM INFORMATION	
S/W VERSION	VER 1.0
H/W VERSION	VER 1.0
PRODUCT ID	01S-2039-001008-AR-01
MASTER	Maxtor 6Y060L0
SLAVE	
CD-R	SAMSUNG CD-R/RW SW-256B

TO EXIT, PRESS [MENU]



## 2) SCHEDULE SETUP

Unless you selected other recording mode, DVR system records in Schedule Recording mode. In SCHEDULE REC SETUP, you set type of recording for every time interval of 2 hours in each day of the week. Schedule Recording set by manufacturer is recording continuously at its full recording speed, and it means DVR system record continuously at 120 ips in total at 720x240 resolution. To set Schedule Recording parameters, enter into SYSTEM MENU-RECORD SETUP-SCHEDULE SETUP and Press the [ENTER] button.

### (1) SCHEDULE SETUP

Set recording type for each recording time interval for a day of the week (2 hours interval).

SCHEDULE REC SETUP							
	SUN	MON	TUE	WED	THU	FRI	SAT
00-02	-M-	AM-	--C	--C-	--C-	--C	--C
02-04	-M-	AM-	--C	--C	--C	--C	--C
04-06	-M-	AM-	--C	--C	--C	--C	--C
06-08	-M-	AM-	--C	--C	--C	--C	--C
08-10	---	AM-	--C-	--C	--C	--C	--C
10-12	---	AM-	--C	--C	--C	--C	--C
MODE: CELL BY CELL							
1 / 2							
▲▼◀▶ & [NEXT], EDIT:+-&[MODE] A:ALARM M:MOTION C:CONTINUOUS							

Use [MODE] button to select edit type and move to the time interval of a day of the week you want to change. Press [ENTER] button to select and use [+] or [-] button, to change the record type. To go next page, use [NEXT] button.

※ MODE (Edit type)

TIME CELL : Set each time interval of a day of the week

WEEK : Set a day of the week at once

TIME ZONE : Set a time slot at once

ALL : Set page by page at once

CLEAR ALL: Clear page by page

※ Unless user press [REC] button to record at full resolution and in SUPER FINE picture quality, DVR system records in SCHEDULE Record mode.

※ DEFAULT record mode for each time interval of a day of the week set by manufacturer is CONTINUOUS recording.

※ Record type :

After power on ⇔ Schedule record

Exit from menu ⇔ Schedule record

End of search or playback ⇔ Schedule record

After pressing [STOP] button ⇔ Schedule record

After pressing [REC] button ⇔ Emergency record (Continuous recording in full performance)  
[120(100) ips at 720x240(720x288)]

## 3) HOLIDAY SETUP

Users can set national holiday or holidays on calendar to record just as setting for Sunday in SCHEDULE REC SETUP.

Use [MODE] button to select a month and direction button to move to a day, and press [ENTER] button to set a holiday. Then color of date shall be changed to red, as Sunday.

EDIT HOLIDAY : Set as holiday

CLEAR MON DATA : Cancel the holiday set per month

CLEAR ALL DATA : Cancel all holiday set

※ The maximum holidays is 100 days.

HOLIDAY SETUP							
< APR >							000/100
SUN	MON	TUE	WED	THU	FRI	SAT	
							01 02
03	04	05	06	07	08	09	
10	11	12	13	14	15	16	
17	18	19	20	21	22	23	
24	25	26	27	28	29	30	
MODE : EDIT HOLIDAY SELECT ▲▼◀▶, EDIT [ENTER]&[MODE]							

## 5-5. BACK-UP

User can back up the recorded data to CD using CD writer installed in DVR.

Refer to [START] and [END] of data on HDD and set copy from time, [START], and size of data copied, [SIZE], and move to BURN and press [ENTER] button to start copy.

CD-R SETUP	CD-R SETUP
HDD [START] 2005/AUG/07 AM04:04:12 [ END ] 2005/AUG/08 PM08:12:23	HDD [START] 2005/AUG/07 AM04:04:12 [ END ] 2005/AUG/08 PM08:12:23
CD-R [START] 2005/AUG/07 AM04:04:12 [ END ] 2005/AUG/08 PM08:12:23 [ SIZE ] 000MB	CD-R 700 MB [START] 2005/AUG/07 AM04:04:12 [ END ] 2005/AUG/08 PM08:12:23 [ SIZE ] 700 MB - > 700MB
BURN	BURN 
SELECT : SETUP BUTTON, JOG SHUTTLE	CD-RW BURNING : IMAGE DATA. SELECT : SETUP BUTTON, JOG SHUTTLE

System Status Messages :

- CD-RW DOOR CLOSE. CHECKING CD-R : Blank CD check
- INPUT BLANK CD : CD writer has no blank CD.
- CD-RW DOOR OPEN : Open CD-RW and insert blank CD -R media into CD drive.
- CD-R MEDIA IS DETECTED : Blank CD-R media has been inserted and detected. DVR system will display size of blank CD-R.

After you set [START] time and [SIZE] in CD-R sub-menu and then select BURN, DVR system starts copying images to CD and shows following message.

```
CD-RW BURNING START
CD-RW BURNING : LEAD-IN
CD-RW BURNING : IMAGE DATA
CD-RW BURNING : CLOSE TRACK
CD-RW DOOR OPEN
```

When burning is completed, CD-R media will be ejected automatically.

To copy more images, repeat above process. In the next back-up process, [START] time in CD-R sub-menu shall be [END] time in previous back-up, and you can copy images in series to many CDs as many as you want.

## 5-6. EXTERNAL DEVICE

Set parameters of external devices connected to DVR, like Ethernet, PTZ camera, RS-232C, etc. Use direction button to move to sub-menu and Press [ENTER] button to set.

### 1) TCP/IP SETUP

TCP/IP function enables user to see live pictures and recorded pictures via the internet.

#### (1) IP CONFIG SETUP :

Show the network information assigned to the DVR unit. If the DHCP setup status is AUTOMATIC, user can set the IP port only and if the DHCP setup status is MANUAL, user must set all parameters. For detail procedure of Remote viewer program installation, refer to CHAP. 6 Software program.(Remote viewer software).

IP CONFIG SETUP	
MAC ADDRESS	----- 00-0A-A2-00-00-00
IP ADDRESS	----- 192.168.001.160
IP PORT	----- 50000
GATEWAY	----- 192.168.001.001
SUBNET MASK	----- 255.255.255.000
DHCP SETUP	AUTOMATIC
SELECT MENU : ▲▼, & [ENTER]	

CONNECTION SETUP	
TIMEOUT	200 MSEC
RETRY COUNT	08

SELECT MENU : ▲▼, & [ENTER]

DHCP SETUP	
DHCP MODE	MANUAL
DNS SERVER	000.000.192.168
IP ADDRESS	192.168.001.160
SUBNET MASK	255.255.255.000
GATEWAY	192.168.001.001

SELECT : ▲▼, CHANGE VALUE : + -

**(2) CONNECTION SETUP :**

- TIME OUT : Adjust TIMEOUT value properly to successfully access to DVMR unit via Internet line. If data transmission speed is high enough, leave TIMEOUT value as set by manufacturer (200 msec), and increase it if data transmission via Internet line is relatively slow. Execute tracert (Tracing Route) in your PC for IP assigned to DVMR unit, and you can figure out how much TIMEOUT value increased.
- RETRY COUNT : Set the retry number of times for network connection.

**2) RS-232C SETUP**

User can control the DVR via RS-232C port.  
Connect DVR to PC via RS-232C port and control DVR using keyboard of PC.  
This function is mainly for programmer who wants to control DVR as part of many devices connected to PC system, as in SI project.

RS-232C SETUP	
SPEED	576000
LENGTH	8
STOP BIT	1
PARITY	NONE

SELECT : ▲▼, CHANGE VALUE : + -

**3) PAN/TILT SETUP**

It is to set parameters for PTZ camera connected to DVR unit. DVR unit already includes all protocols of well-known PTZ cameras like PELCO D type PTZ camera, and user just select MODEL and set other parameters to control this PTZ cameras, using operation buttons on the front panel of DVR. If PTZ camera whose protocol is not incorporated into this DVR unit, user must input protocol of this PTZ camera by himself. Using USB device port, user can upgrade protocol for PTZ camera.

PAN/TILT SETUP	
COMMAND SETTING	← PTZ camera set
SPEED SETTING	← PTZ speed set

SELECT : ▲▼, & [ENTER]

COMMAND SETTING	
CHANNEL	01
MODEL	PELCO-D
PTZ ID	000
BAUDRATE	2400 BPS
CMD DELAY	1 MSEC
COMMAND	PAN/TILT STOP
LENGTH	0.7
CODE	FF 00 00 00 00 00 00 00

SELECT : ▲▼, CHANGE VALUE : + -

- 1) CHANNEL : Select channel
- 2) MODEL : Select camera model (protocol type) per each channel
- 3) PTZ ID : Select ID
- 4) BAUDRATE : Select data transmission speed
- 5) CMD DELAY : Select command delay time

**5-7. FACTORY DEFAULT**

Set the all system parameters as manufacturer first set before delivery. It is a kind of system initialization, and manufacturer recommends to do it when you add new HDD or other changes in system to make all system ready for normal operation.

Use direction button to move and Press [ENTER] button to change parameters. After move to RUN, Press [ENTER] button for actual Factory Default setting.

FACTORY DEFAULT	
ALL	OFF
SCREEN DISPLAY	OFF
CAMERA SETTING	OFF
MOTION SETUP	OFF
PANTILT SERUP	OFF
SCHEDULE SETUP	OFF
CONFIGURATION	OFF
RUN	
SELECT MENU : ▲ ▼, & [ENTER]	

**5-8. LANGUAGE SETUP**

The menu can be displayed in a number of languages. Press [ENTER] button to select your language.

SYSTEM MENU	
DISPLAY SETUP	
CONFIGURATION	
RECORD SETUP	
EXTERNAL DEVICE	
FACTORY DEFAULT	
LANGUAGE	ENGLISH
SELECT MENU : ▲ ▼, & [ENTER]	

## CHAP. 6 Network Setup

### 6-1. DVR Network Configuration

Please call your provider to identify what type of service they are providing you.  
You will need to know following ;

Upload speed – For your own knowledge for expected frame rates

Download speed – For your own knowledge for expected frame rates

Addressing – For determining what scenario you should follow

Router On Site or Just a Modem – For determining what scenario you should follow

※NOTE : If your provider is using PPPOE (usually DSL providers), you **MUST** have a IP Share installed on site and follow **3) Dynamic IP of PPPOE (DSL)** for DVR setup and access.

※PLEASE verify Internet access after installing any new equipment (routers, switches, modems, etc.).

### PC's TCP/IP Setting

Before configuring the DVR, please fill out the information below if applicable ;

Choose any PC on your network and determine its TCP/IP settings;

IP Address : \_\_\_\_\_(ex.192.168.1.5)

Subnet Mask : \_\_\_\_\_(ex. 255.255.255.0)

Default Gateway : \_\_\_\_\_(ex.192.168.1.1)

**Next pages are several network scenarios.** Please identify which scenario your current network falls within and follow the instructions for configuring and accessing your DVR via TCP/IP.

## 1) Static IP

**User input IP address in IP CONFIG SETUP which is assigned from ISP company.**

1. Verify if IP address is OK or not with PC before connecting DVR.
2. Connect LAN cable to DVR after confirmation.
3. DVR : MENU → EXTERNAL DEVICE → TCP/IP
4. Set DHCP to MANUAL and go into TCP/IP SETUP.
5. Verify if MAC ADDRESS starts from 00-0A-A2....
6. Input IP address which is assigned from ISP company.
7. Set IP PORT. (50000 recommended)
8. Input GATEWAY which is assigned from ISP company.
9. Input SUBNET MASK which is assigned from ISP company.
10. Go out of MENU SETUP.
11. Turn off and on Modem (Router) which is provided by ISP company.  
→ This is to reset client of MAC from ISP company.  
User have to wait for 30 seconds after turning on.
12. Access DVR with Remote Viewer software.

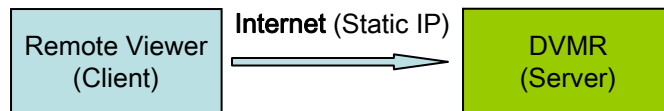

\* If user fail to access, please verify 1, 6, 7, 8, 9, 11 again.

\* When speed is too slow and connection fails after access : MENU → EXTERNAL DEVICE → TCP/IP SETUP → CONNECTION SETUP  
Increase value of Timeout to find the most suitable speed.

## 2) Dynamic IP

1. Verify if IP address is OK or not with PC before connecting DVR.
2. Connect LAN cable to DVR after confirmation.
3. Turn off and on Modem (Router) which is provided by ISP company.  
→ This is to reset client of MAC from ISP company.  
User have to wait for 30 seconds after turning on.
4. Turn off and on DVR.
5. DVR : MENU → EXTERNAL DEVICE → TCP/IP
6. Verify if MAC ADDRESS starts from 00-0A-A2....
7. Set DHCP to AUTOMATIC and detect IP to get Dynamic IP.
8. Go out of MENU SETUP after getting IP successfully.
9. Access DVR with Remote Viewer software.

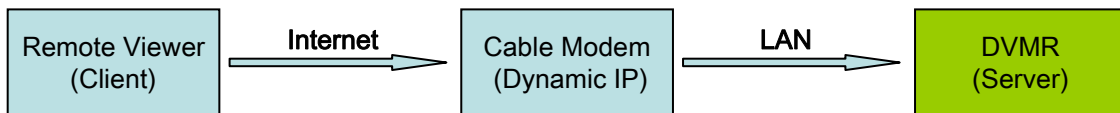

\* If user fail to access, please verify 1, 3, 4 again.

\* When speed is too slow and connection fails after access : MENU → EXTERNAL DEVICE → TCP/IP SETUP → CONNECTION SETUP  
Increase value of Timeout to find the most suitable speed.

### 3) Dynamic IP of PPPoE (DSL)

**DVR doesn't support DSL (PPPoE), user have to set NETWORK with IP SHARE if user need to access DVR remotely. At this time, User have to port forward on DVR. Please contact IP SHARE Manufacturer if you need to know how to forward port.**

**Even though user have Static/Dynamic IP, if user want to use another device (PC) through IP SHARE, user can set NETWORK as follows,**

1. Verify if IP address is OK or not with PC before connecting DVR.
2. Connect Router (IP SHARE) to DSL modem as shown the following picture.
3. Set the internet connection on Router (IP SHARE). (Refer to the Router Manual.)
4. Verify if sub-group of network in Router is OK or not.
5. Connect DVR to Router.
6. DVR : MENU → EXTERNAL DEVICE → TCP/IP
7. Set DHCP to MANUAL and go into TCP/IP SETUP.
8. Verify if MAC ADDRESS starts from 00-0A-A2....
9. Input internal IP address which user assigned from Router.
10. Set IP PORT. (50000 recommended)
11. Input GATEWAY of Router.
12. Input SUBNET MASK of Router.
13. Go out of MENU SETUP.
14. Forward port from Router. (Refer to the Router Manual.)
15. Access DVR with external IP and Port (Port forwarded).

\* If Router support DDNS, user can access Remote Viewer using Domain Information.

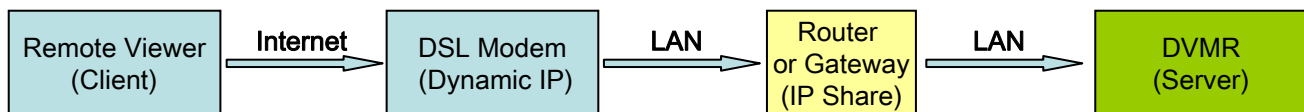

\* If user fail to access, please verify 1, 4, 15 again.

\* When speed is too slow and connection fails after access : MENU → EXTERNAL DEVICE → TCP/IP SETUP → CONNECTION SETUP  
Increase value of Timeout to find the most suitable speed.

## 6-2. Remote Viewer program

### MAIN INTERFACE

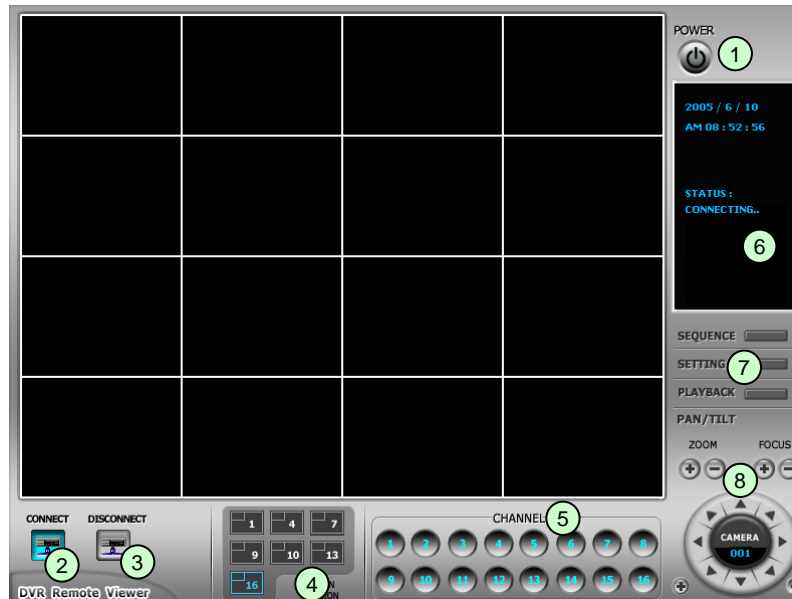

- ① - **Power button** : Press the Power switch to exit the program. Please disconnect the live feed before powering off the software
- ② - **Connect button** : Press the Connect button to view the live images from the DVR. These are the same images being displayed on the monitor of the DVR, with a delay depending on your internet connection at both the DVR location and from where you're currently accessing.
- ③ - **Disconnect button** : Press this button to disconnect from the DVR unit. Then you may power off the software.
- ④ - **Screen Division button** : Select how many channels to view simultaneously (single, 4-split, 9-split, or 16-split). When you select a view you will see the Channel Numbers highlighted which determine what channels are currently being viewed.
- ⑤ - **Channel number button** : Select the channel that you want to view based on what Screen Division view is enabled.
- ⑥ - **Status window** : Display's the current time and date based. The date is in the format : Year/Month/Day. You will also see the status of your connection.
- ⑦ - **Setting, Playback, and Sequence buttons** ;
  - a. Setting : Enables the software configuration screen.
  - b. Playback : Enables the remote playback screen.
  - c. Sequence : When in single channel view, hitting the sequence button will sequence through all active channels at a speed specified in the settings menu.
- ⑧ - **PTZ control** : You can control a PTZ camera via the software with these controls.
  - a. First, you must input or configure the specific PTZ protocol into the software in order to communicate with the PTZ device.
  - b. When you press any of the controls for the PTZ, please press and hold the button for 1-2 seconds per instance to compensate for the data transmission rate. If you do not and instead simply click the PTZ buttons, you may get undesired results (having the requested operation transmitted repeatedly, regardless of your intention).
  - c. The plus and minus buttons send the PTZ commands to the corresponding PTZ camera ID.

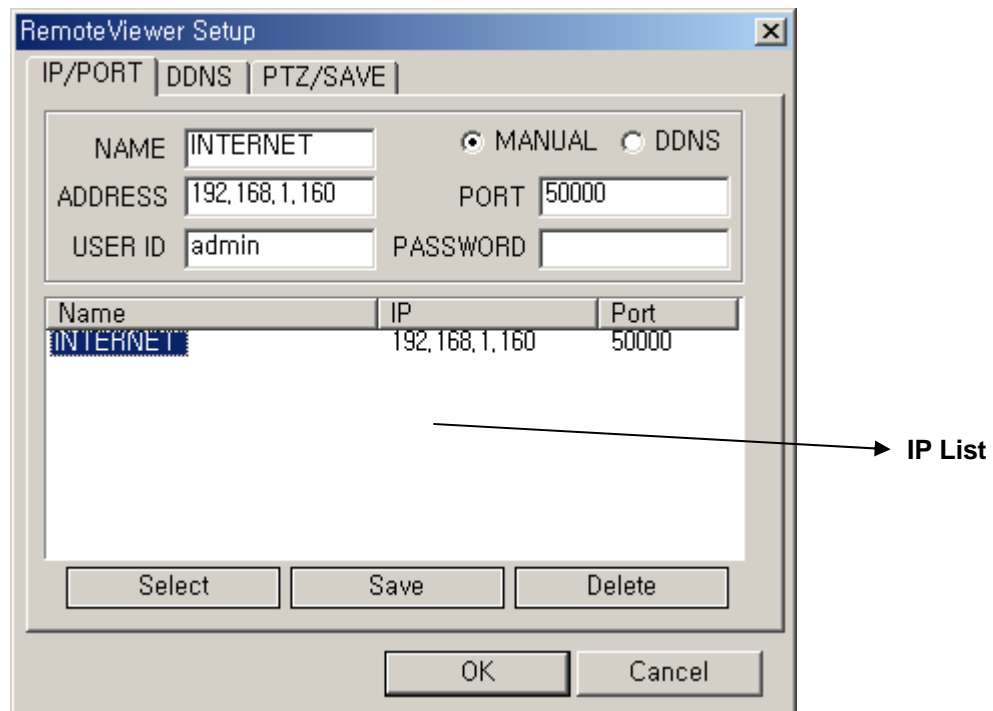
**IP/PORT Setting Screen****MANUAL  
DDNS**

Input IP address and PORT manually  
 Receive IP address and PORT from DDNS Server.  
 For further information of DDNS, please contact your vendor.

**Name  
Address  
PORT  
ID  
Password**

Name of IP address on the list.  
 Input IP address which is set on DVR  
 Input PORT which is set on DVR  
 Input ID which is set on DVR. (Please input 'admin'.)  
 Input password which is set on DVR

**IP List** It shows IP list which user input manually.

**Select Button** Select IP and PORT on the list.  
**Save Button** Save IP and PORT on the list.  
**Delete Button** Delete IP and PORT on the list.

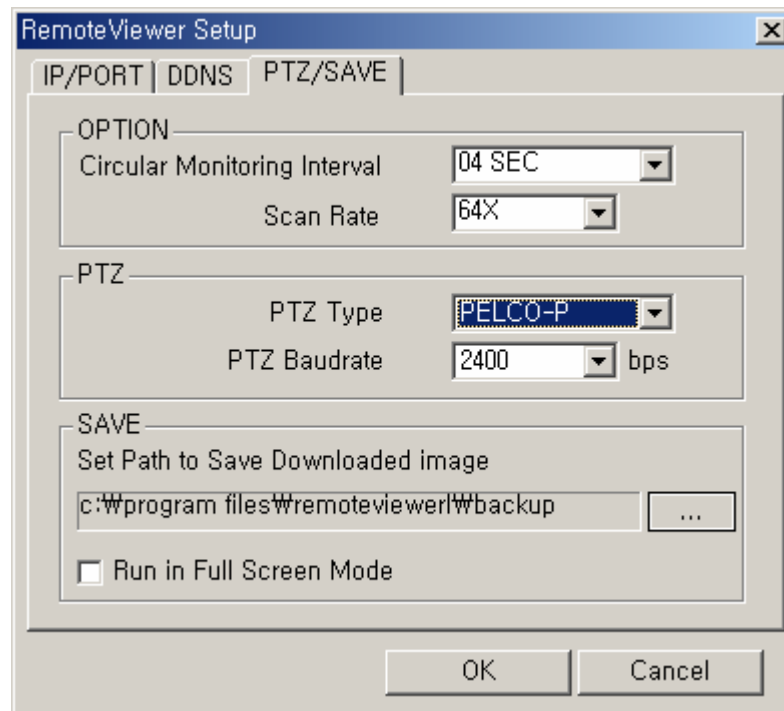
**PTZ/SAVE Setting Screen**

**Circular Monitoring Interval** : This indicates the speed of the channels sequence when the SEQUENCE button is used from the main interface.

**Scan Rate** : Set speed of playback.

**PTZ TYPE** : Select PTZ camera which is connected to DVR.

**PTZ Baud Rate** : Enter the Baud Rate of your PTZ camera.

**Set Path to Save Downloaded image** : Determines the location and folder on your PC where the downloaded video clips are stored.

**Run in full screen mode** : When checked, this will enable the program to re-adjust the interface to completely fill your computer screen.

## PLAYBACK INTERFACE through Remote Viewer

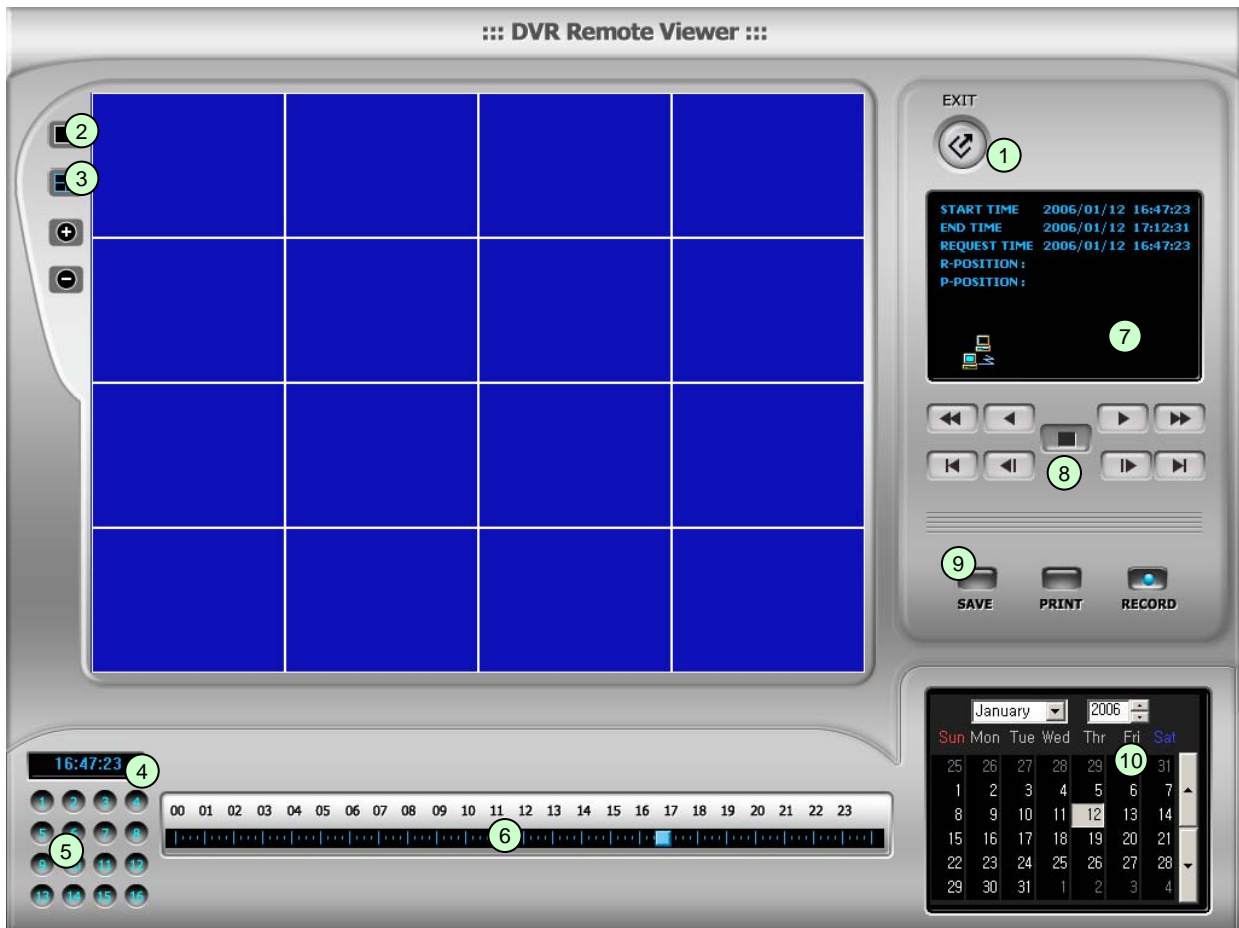



Function of each button in Search window.

- ① **Exit** : Exit to live window.
- ② **Full screen** : Select a certain camera to view in full screen.
- ③ **Quad** : To view quad mode (4 channels at the same time)
- ④ **Time** : The recording time & date information of the pictures which is being played.
- ⑤ **Channel selection** : Select each camera.
- ⑥ **Time selection** : Select a time from which user want to see. The playback will be started from this point.(drag the point using mouse)
- ⑦ **Start and end time** : Indicate record starting time and end time of images on HDD
- ⑧ **Other operating button** : Refer to the next page description.

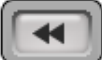

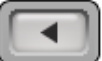
 : Play fast backward

 : Play backward(1X)

 : Play forward(1X)

 : Play fast forward

 : Stop playback

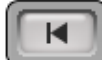
 : Move to the start of recording

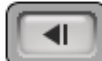
 : Move to the previous hour

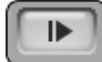
 : Move to the afterward hour

 : Move to the end of recording

⑨ : Command button.

**a) SAVE** : After pressing the Stop button, click SAVE button to save the currently viewed image in jpg format.

**b) PRINT** : After pressing the Stop button, click PRINT button to print the currently viewed image.

**c) RECORD** : Press this button to download playback images transmitted from DVR unit into your PC. User can see saved images using Windows Media Player.

⑩ : Calendar

Use this to select the date you wish to search. The filled in square outlines the date that is at the beginning of the hard drives. The outlined square indicates the data at the end of the hard drives. Select the date you wish to view. Verify a filled in square for that particular date. If an invalid date is selected it will default to the beginning of the hard drive(s).

## 6-3. Back-up CD Player

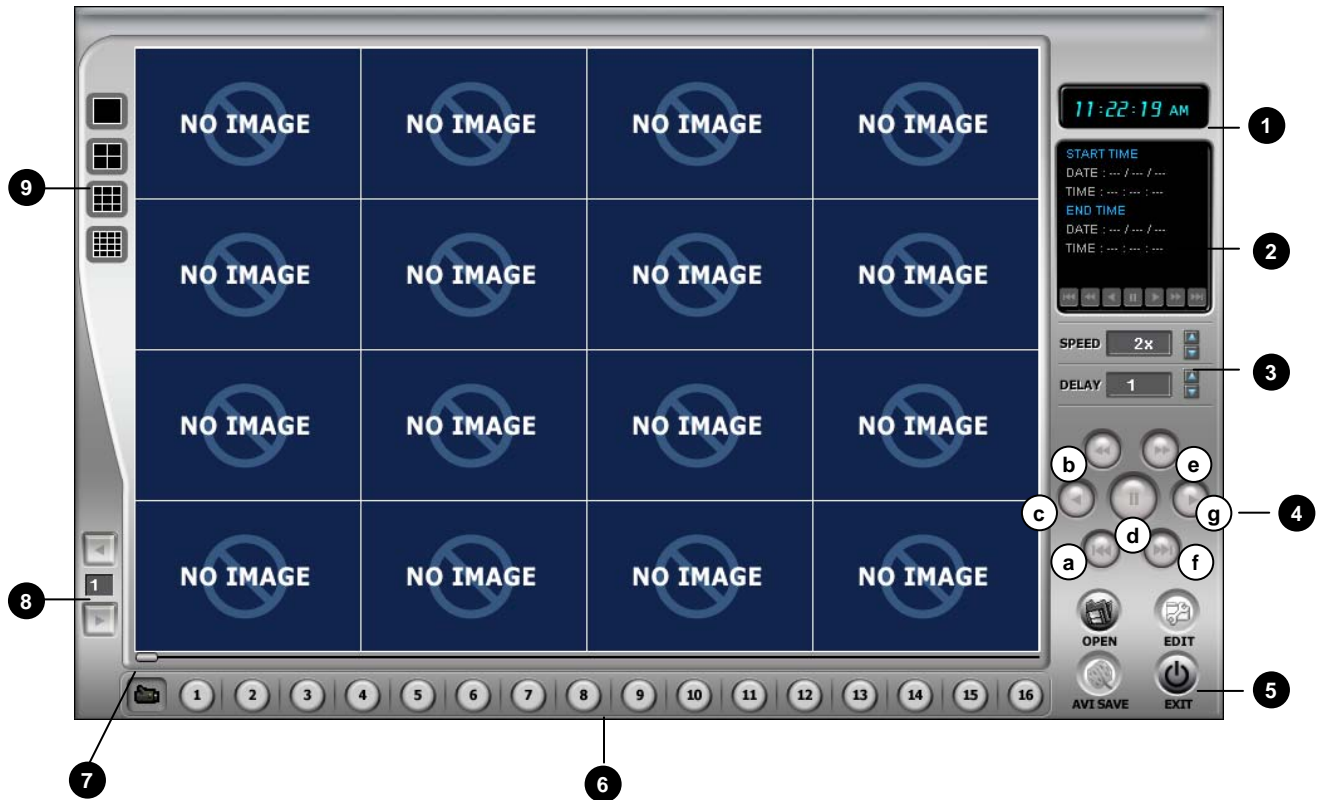

DVR units are with a built-in CD-RW, and user can copy images to CD.

Using back-up CD player, user can see images on back-up CD, and function of each button in Back-up CD player is as below.

- 1 **Time** : Current time.
- 2 **Status Window** : Start & End of time & date, Status of operating button.  
When user play forward/backward, recorded time will appear.
- 3 **Play Speed button** : User can adjust play speed by pressing up/down button.  
Speed (1/4X, 1/2X, 1X, 2X, 4X, 8X, 16X) Delay : (1, 2, 4, 8, 16, 32)
- 4 **Operation button** : User can search recorded data using these buttons.
  - a) Move the slide bar to start position
  - b) Play fast backward in preset speed
  - c) Play backward at 1x speed
  - d) Pause
  - e) Play forward at 1x speed
  - f) Play fast forward in preset speed
  - g) Move the slide bar to end position
- 5 **Function button**
  - a) OPEN : Open the Back-up CD Player.
  - b) EDIT : User can edit, save and print recorded image on Edit mode. This edit button will work when you selected one of 16 cameras.
  - c) EXIT : Exit from Back-up CD Player.
- 6 **Channel button** : Select channel to see pictures in full screen.
- 7 **Slide Bar** : Move to a point from which user want to see.
- 8 **Page button** : This button is just working when screen-division is 4-split in 8 ch DVR, or 4-split or 8-split in 16 ch DVR. Moves to next page.
- 9 **Screen division** : 1/4/9/16

## Image EDIT

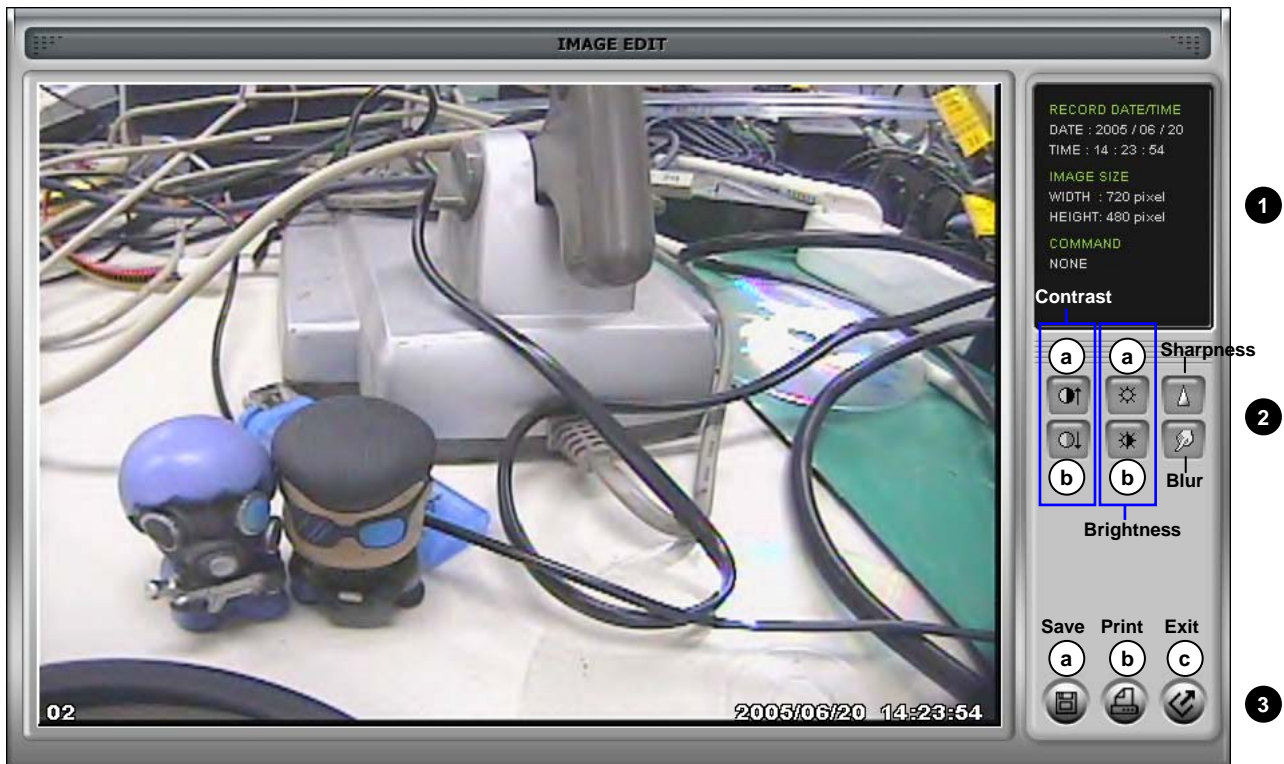

**1. Image Edit Status Window** : Shows record time & date, Image size, Command status.

**2. Edit Button** : User can adjust color tone of copied images using this button.

- Contrast :
  - a) make bright part of image brighter and dark part of image darker
  - b) To reduce light and shade, lower contrast a little
- Brightness
  - a) make an image brighter
  - b) make an image darker
- Sharpness : give sharp-edge effect
- Blur : make an image soft

**3. Function button**

- a) Save : User can save an image in JPEG format. It is saved in the folder where you installed back-up CD player.
- b) Print : User can print current image user selected
- c) EXIT : Return to Back-up CD Player mode.

## Stand-alone DVR

**CHAP. 7 Specifications**

- The best picture quality in Playback(JPEG-2000)
- Real time live display in all channels
- 16 channel video 240(200)ips recording capability
- Triplex (Playback/Recording/Ethernet)
- Multi-language menu
- Remote monitoring and download through network
- Convenient search function with Jog/shuttle
- VGA option available (Supporting TFT LCD Monitor)
- USB (Device) port for firmware upgrade
- Easy PTZ camera control by pre-assigned buttons
- Password Protection
- Remote Controller

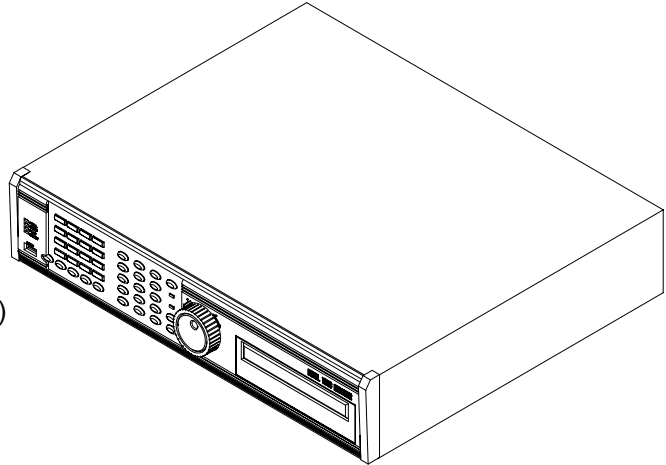

Multiplex function		Triplex (Playback/Recording/Ethernet)	
Storage	Internal	HDD	Up to 2 HDDs with no limitation in capacity
Capacity		CD-RW	For Backup
Video	Inputs	Composite	16Ch
	Outputs	Composite	2Ch (Monitor / VCR)
		VGA	1Ch (Supporting TFT LCD Monitor/Option)
		Loop out	16Ch
	Compression		JPEG-2000
Compression Rate (Image size fixed)			Basic
			Normal
			Enhanced
			Fine
			Super Fine
	Display Speed		Real Time display
Recording /Search	Recording Mode	Schedule (Time, Motion, Alarm), Emergency	
	Search	Event Search, Date/Time Search, Search Bar (Jog/Shuttle)	
	Recording Speed (NTSC/PAL)	Full (120/100), Dual (240/200)	
	Recording Resolution (NTSC/PAL)	Full (720x240/720x288), Dual (360x240/360x288)	
Multi-language	English, Spanish, German, Italy, France, to be added more		
Switching Interval	1~99 sec selectable		
Live Division Screen	1 / 4/ 6/ 8/ 9/ 13/ 16 Split		
	Digital Zoom, Freeze function available in Live mode, PIP, SEQ		
Alarm	Inputs	16 Alarms (NO/NC selectable in SETUP menu)	
	Outputs	1 (NO/NC)	
	Post Alarm	Duration of alarm output : 1 sec ~ 300 sec selectable	
Motion Detection	Area division : 16 x12 / Detection Division : 32 x 24		
Network	Ethernet (TCP/IP), Remote viewer program included		
Backup	VCR, CD-RW back-up, Download via IP Network		
PTZ Control	RS-485, Key Control( Key assigned for each PTZ command)		
Firmware upgrade	USB port for firmware upgrade, CD-R		
Serial I/F	RS-485	For PTZ camera control	
	RS-232C	For operation using keyboard of PC	
Power Requirements	DC 12V 8.3A Adaptor		
Weight	8.5kg		
Dimensions (WXHXD) mm	436 X 396 X 88		
Packing	600 X 520 X 180		

Design and specifications are subjected to changes without notice

Stand-alone DVR

MEMO :



---

**Best Picture Quality - JPEG2000**